

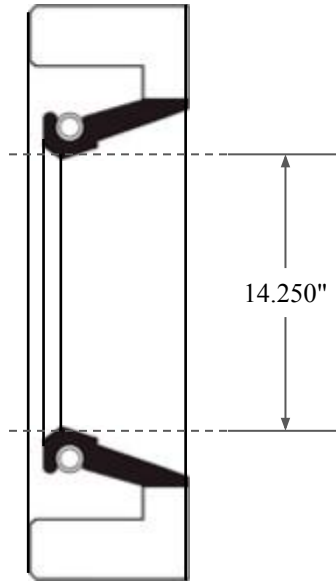

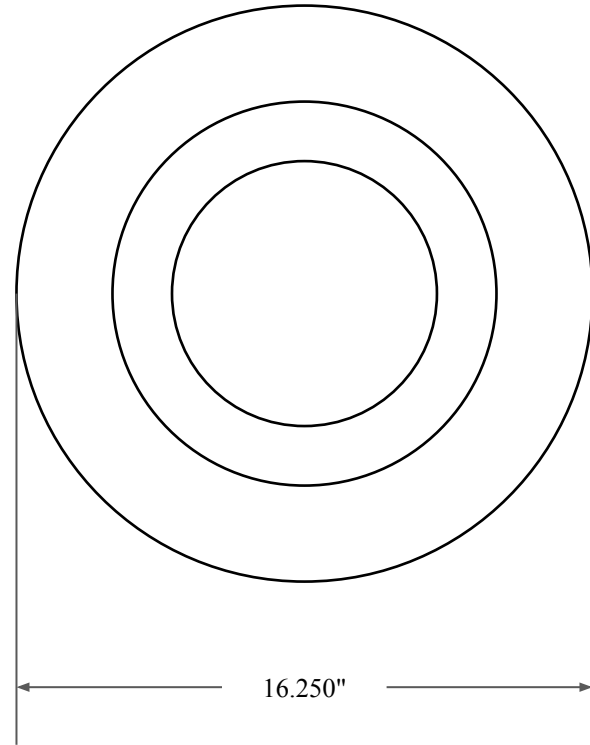

0.625"



14.250"



16.250"

 GLOBAL O-RING and SEAL ALL-AROUND BETTER	PART NUMBER FRS14344AV90
14450 John F. Kennedy Blvd. Houston, TX 77032	Fabric Reinforced Oil Seal - Viton 90 Style A Ref: JM Clipper 11750 H5MX5489
Information in this drawing is provided for reference only	