

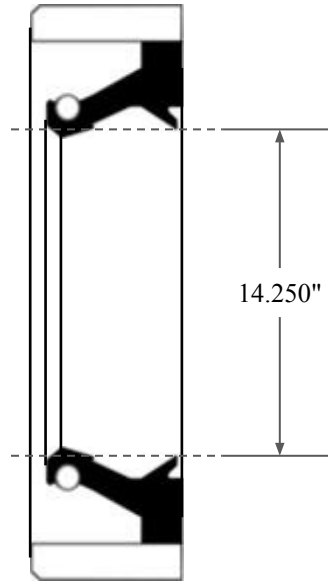

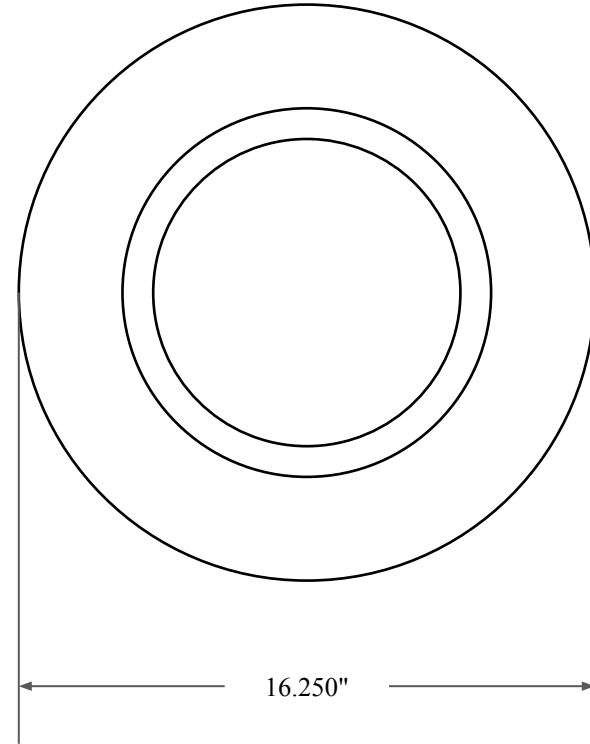

0.688"



14.250"



16.250"

 GLOBAL O-RING and SEAL ALL-AROUND BETTER	PART NUMBER FRS14345C
14450 John F. Kennedy Blvd. Houston, TX 77032	Fabric Reinforced Oil Seal - Nitrile 90 Style C Ref: JM Clipper 20596 H1L5
Information in this drawing is provided for reference only	