

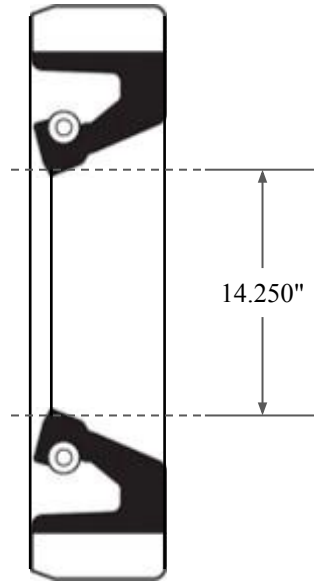

1.000"

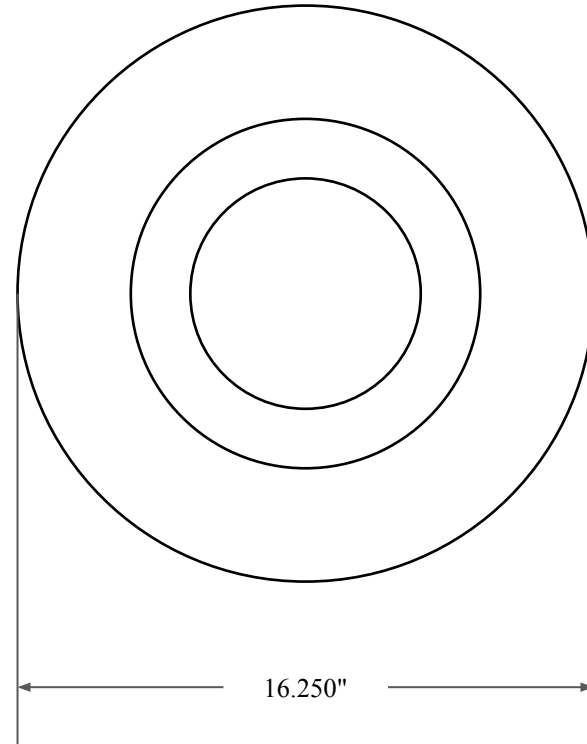

14.250"



16.250"



**GLOBAL O-RING**  
and SEAL  
ALL-AROUND BETTER

14450 John F. Kennedy Blvd.  
Houston, TX 77032

[www.globaloring.com](http://www.globaloring.com)

PART  
NUMBER

**FRS14348B**

Fabric Reinforced Oil Seal - Nitrile 90 Style B  
Ref: JM Clipper 9447 H1L5

Information in this drawing is provided for reference only