

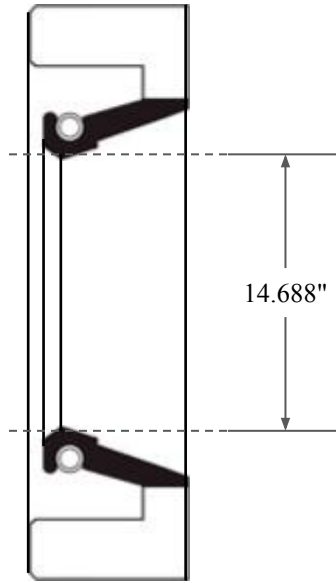

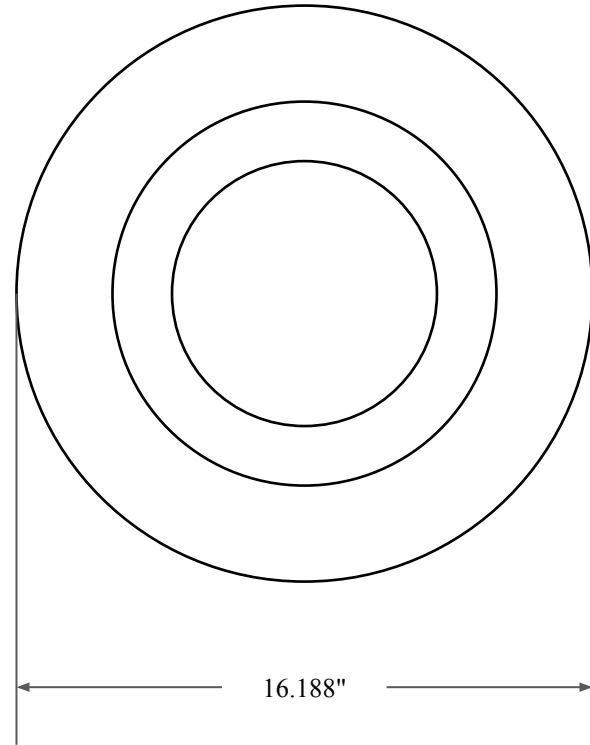

0.625"



14.688"



16.188"

 GLOBAL O-RING and SEAL ALL-AROUND BETTER	PART NUMBER FRS14381AV90
14450 John F. Kennedy Blvd. Houston, TX 77032 www.globaloring.com	Fabric Reinforced Oil Seal - Viton 90 Style A Ref: JM Clipper 9419 H5L16
Information in this drawing is provided for reference only	