

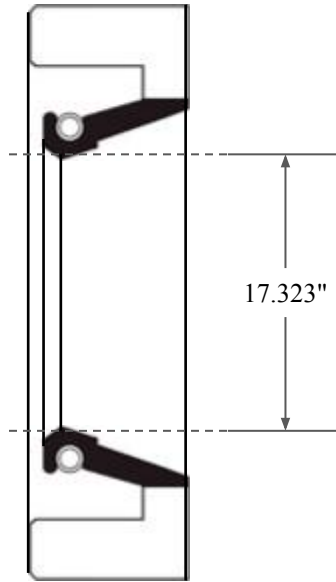

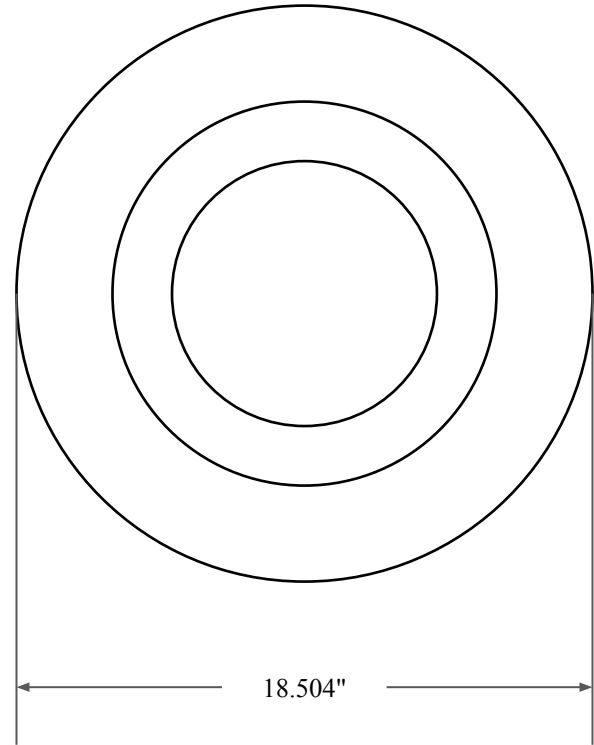

0.787"



17.323"



18.504"

 GLOBAL O-RING and SEAL ALL-AROUND BETTER	PART NUMBER FRS14589AV90
14450 John F. Kennedy Blvd. Houston, TX 77032 www.globaloring.com	Fabric Reinforced Oil Seal - Viton 90 Style A Ref: JM Clipper 19876 H5L16
Information in this drawing is provided for reference only	