

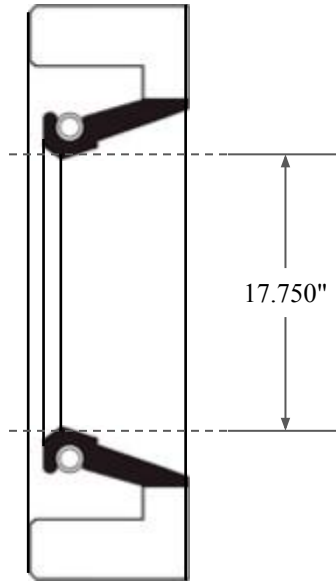

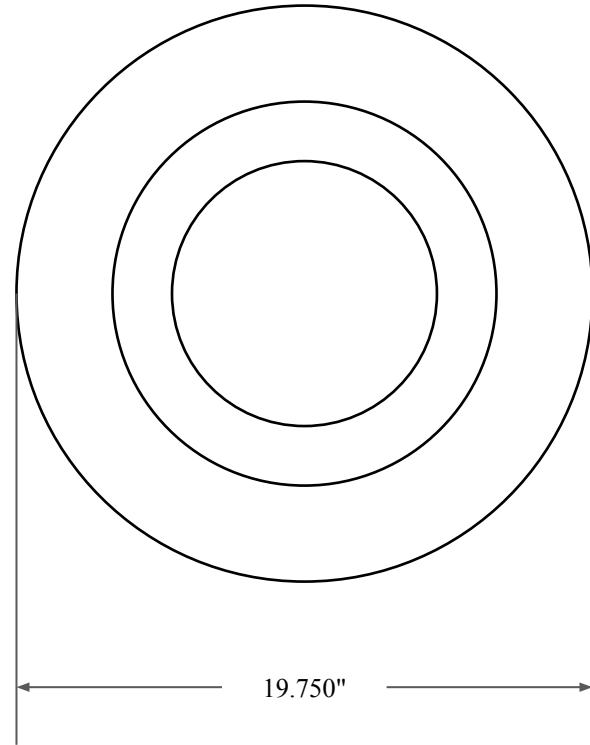

0.813"



17.750"



19.750"

 GLOBAL O-RING and SEAL ALL-AROUND BETTER	PART NUMBER FRS14621AV90
14450 John F. Kennedy Blvd. Houston, TX 77032 www.globaloring.com	Fabric Reinforced Oil Seal - Viton 90 Style A Ref: JM Clipper 9624 H5L16
Information in this drawing is provided for reference only	