

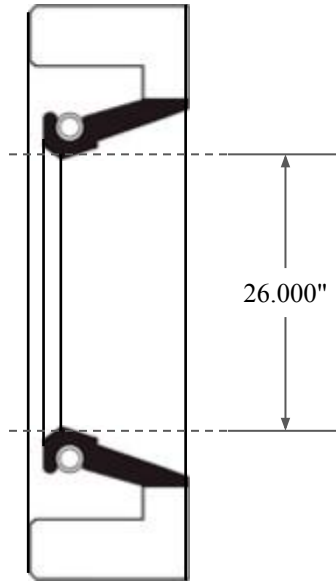

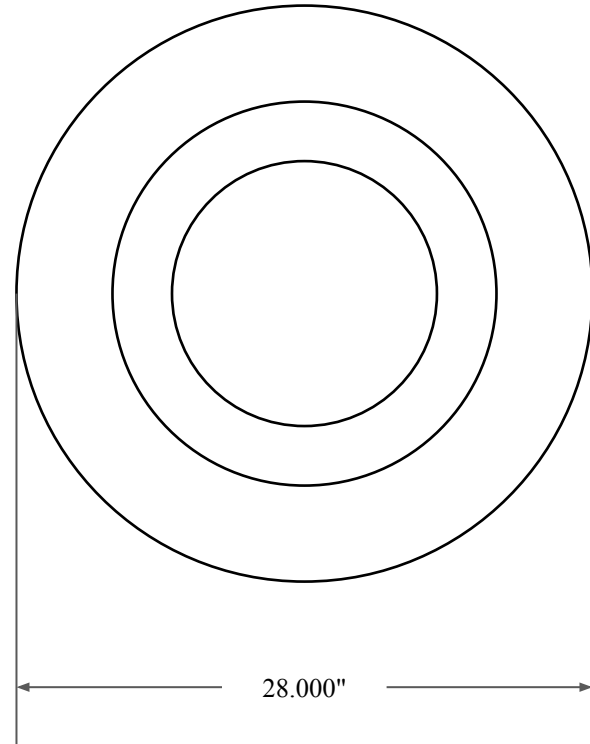

0.875"



26.000"



28.000"

 GLOBAL O-RING and SEAL ALL-AROUND BETTER	PART NUMBER FRS14955AV90
14450 John F. Kennedy Blvd. Houston, TX 77032	Fabric Reinforced Oil Seal - Viton 90 Style A Ref: JM Clipper 16221 H5MX5489
Information in this drawing is provided for reference only	