

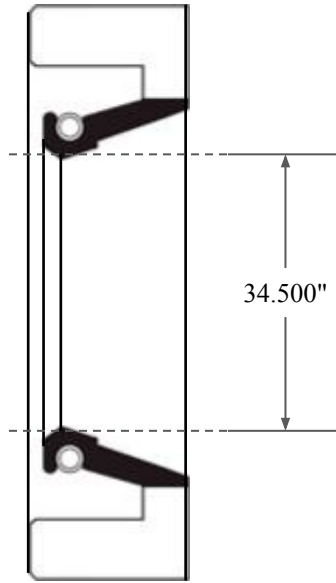

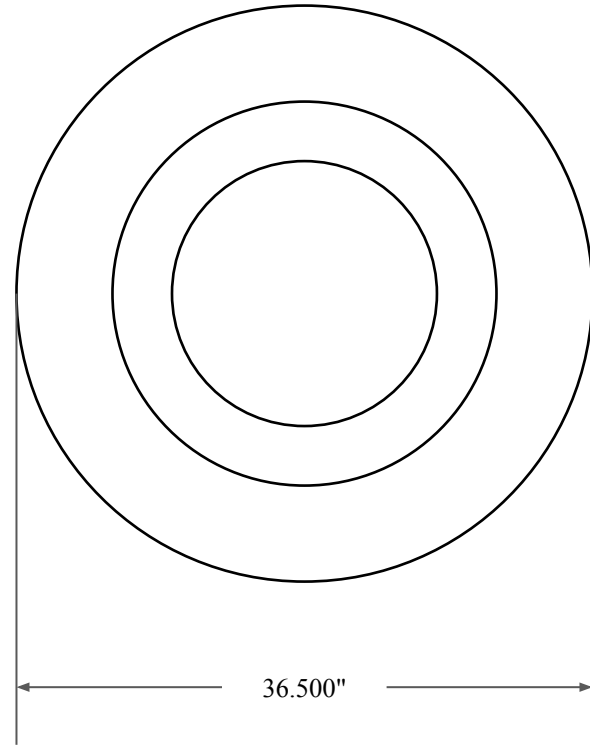

1.000"



34.500"



36.500"

 GLOBAL O-RING and SEAL ALL-AROUND BETTER	PART NUMBER FRS15137AV90
14450 John F. Kennedy Blvd. Houston, TX 77032	Fabric Reinforced Oil Seal - Viton 90 Style A Ref: JM Clipper 10274 HSL16
Information in this drawing is provided for reference only	