

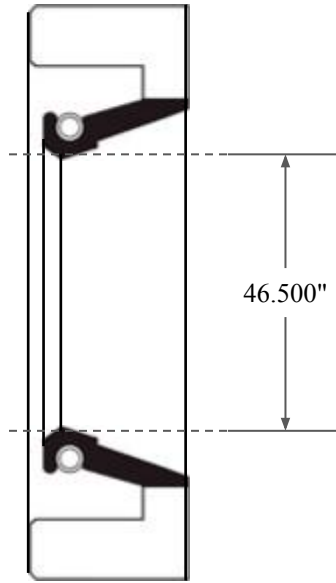

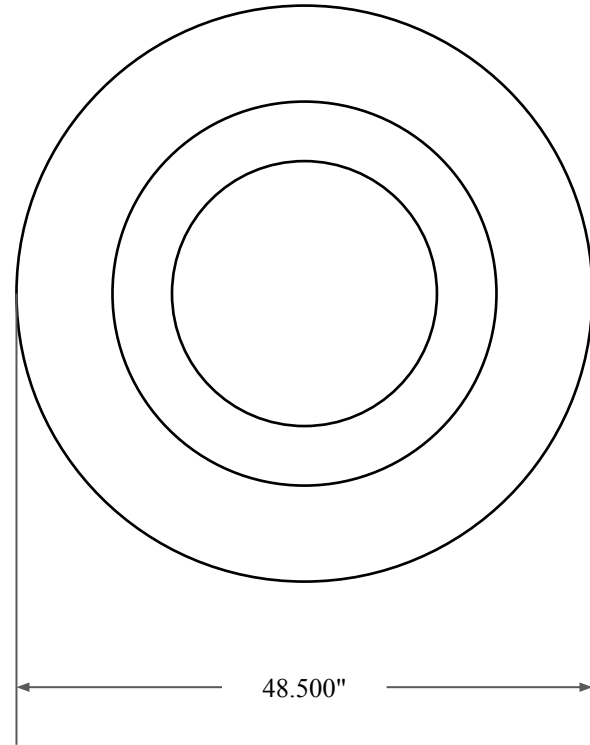

0.875"



46.500"



48.500"

 GLOBAL O-RING and SEAL ALL-AROUND BETTER	PART NUMBER FRS15237A
14450 John F. Kennedy Blvd. Houston, TX 77032	Fabric Reinforced Oil Seal - Nitrile 90 Style A Ref: JM Clipper 19862 H1L5
Information in this drawing is provided for reference only	