

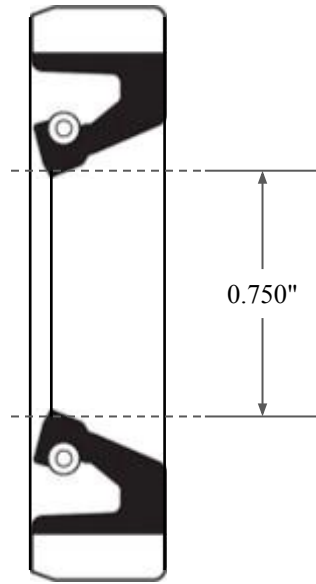

0.312"

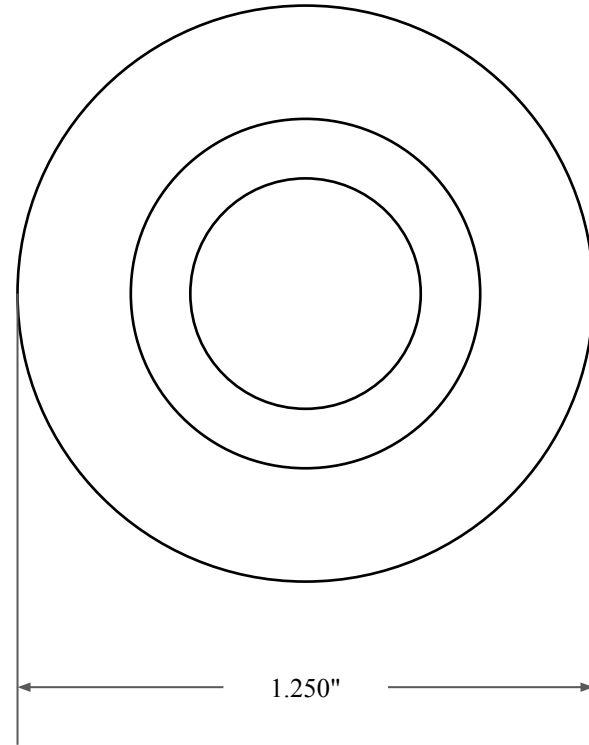

0.750"



1.250"



**GLOBAL O-RING**  
and SEAL  
ALL-AROUND BETTER

14450 John F. Kennedy Blvd.  
Houston, TX 77032

[www.globaloring.com](http://www.globaloring.com)

PART  
NUMBER

**FRS1777B**

Fabric Reinforced Oil Seal - Nitrile 90 Style B  
Ref: JM Clipper 0075 4187

Information in this drawing is provided for reference only