

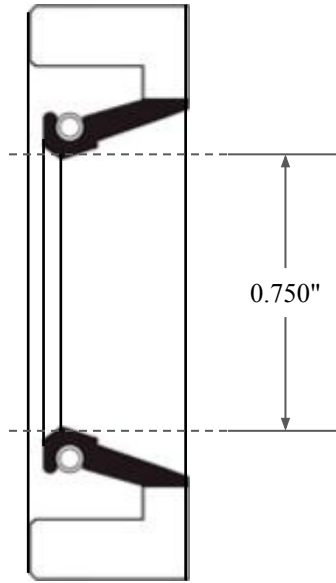

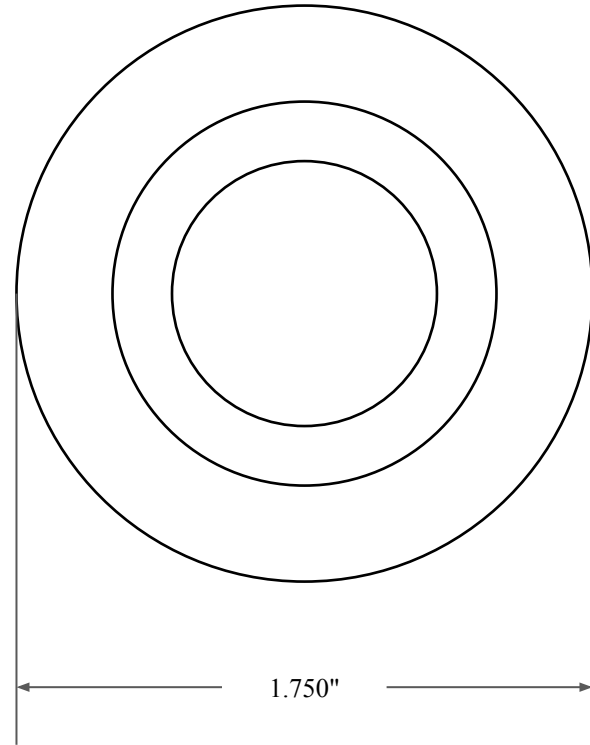

0.375"



0.750"



1.750"

 GLOBAL O-RING and SEAL ALL-AROUND BETTER	PART NUMBER FRS1827AVT90
14450 John F. Kennedy Blvd. Houston, TX 77032	Fabric Reinforced Oil Seal - Viton/PTFE 90 Style A Ref: JM Clipper 9983 H5MX5489
Information in this drawing is provided for reference only	