

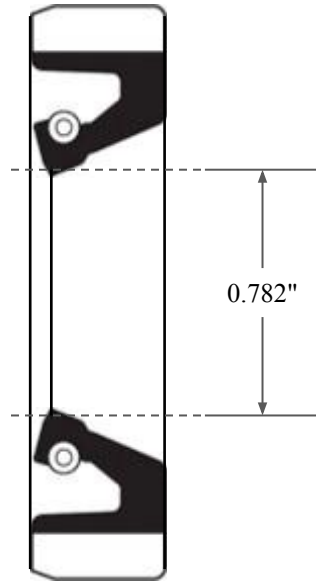

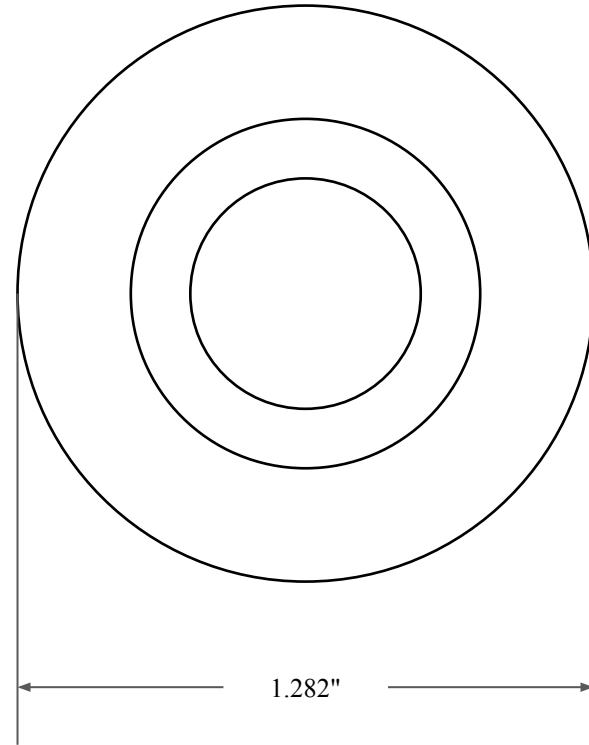

0.312"



0.782"



1.282"

 GLOBAL O-RING and SEAL ALL-AROUND BETTER	PART NUMBER FRS1877B
14450 John F. Kennedy Blvd. Houston, TX 77032	Fabric Reinforced Oil Seal - Nitrile 90 Style B Ref: JM Clipper 0078 4187
Information in this drawing is provided for reference only	