

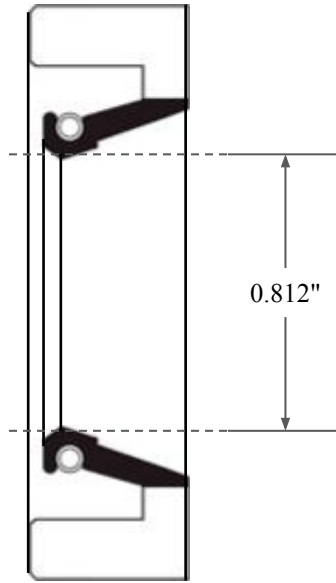

0.312"

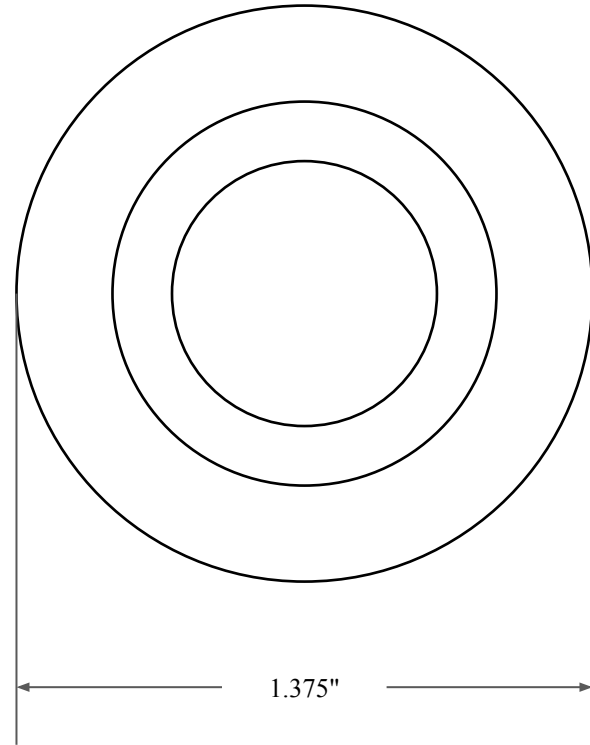

0.812"



1.375"



14450 John F. Kennedy Blvd.  
Houston, TX 77032

[www.globaloring.com](http://www.globaloring.com)

PART  
NUMBER

**FRS2068A**

Fabric Reinforced Oil Seal - Nitrile 90 Style A  
Ref: JM Clipper 9743 H1L5

Information in this drawing is provided for reference only