

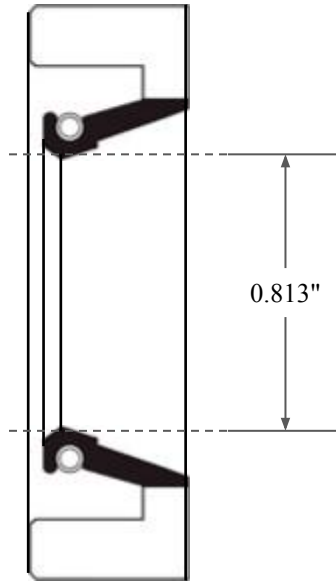

0.391"

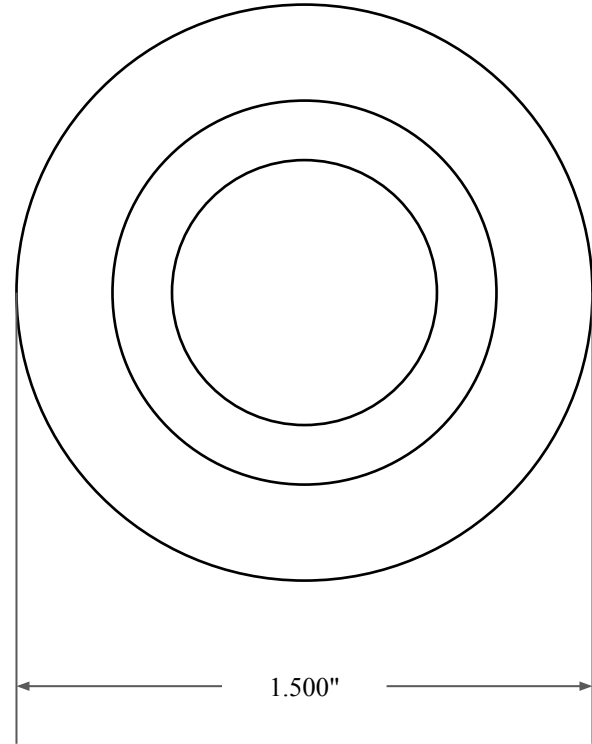

0.813"



1.500"



14450 John F. Kennedy Blvd.
Houston, TX 77032

www.globaloring.com

PART
NUMBER

FRS2099AV90

Fabric Reinforced Oil Seal - Viton 90 Style A
Ref: JM Clipper 7348 H5L16

Information in this drawing is provided for reference only