

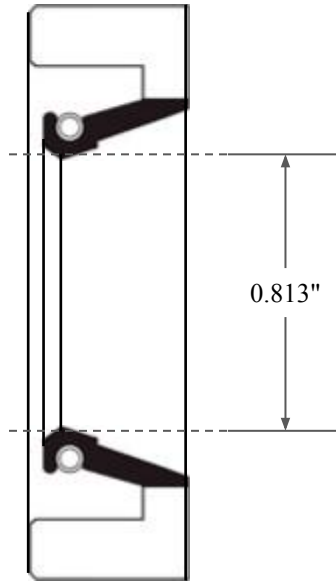

0.431"

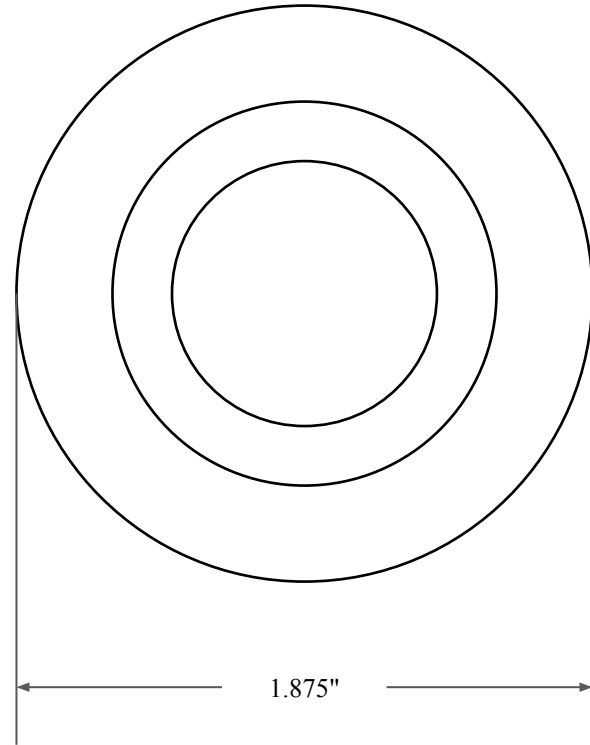

0.813"



1.875"



14450 John F. Kennedy Blvd.
Houston, TX 77032

www.globaloring.com

PART
NUMBER

FRS2106A

Fabric Reinforced Oil Seal - Nitrile 90 Style A
Ref: JM Clipper 13647 H1L5

Information in this drawing is provided for reference only