

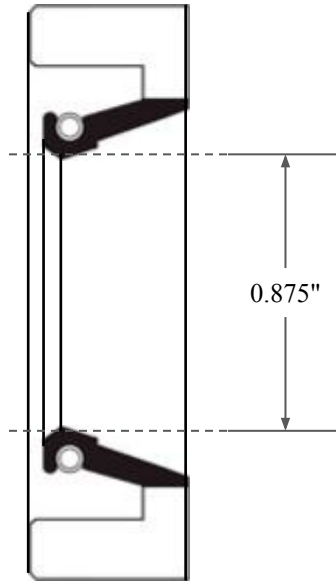

0.406"

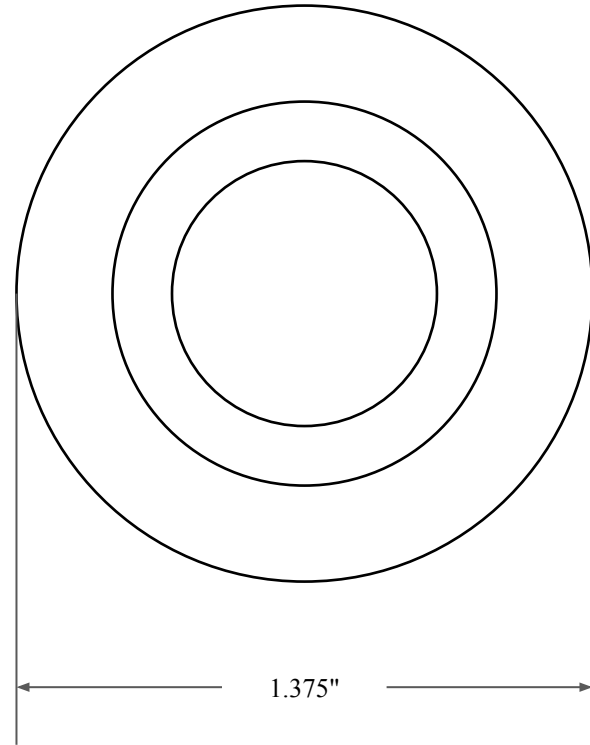

0.875"



1.375"



14450 John F. Kennedy Blvd.
Houston, TX 77032

www.globaloring.com

PART
NUMBER

FRS2323AV90

Fabric Reinforced Oil Seal - Viton 90 Style A
Ref: JM Clipper 9421 H5L89

Information in this drawing is provided for reference only