

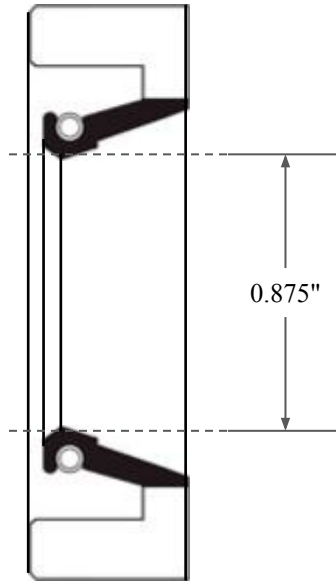

0.313"

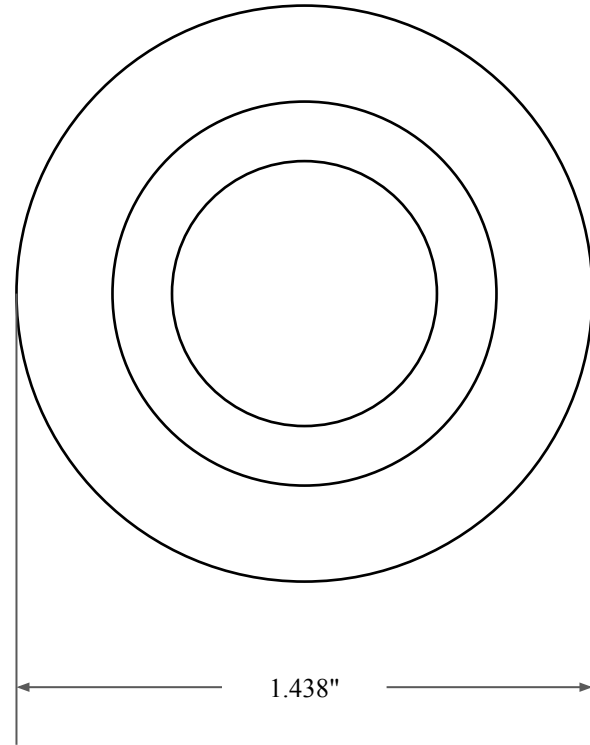

0.875"



1.438"



14450 John F. Kennedy Blvd.
Houston, TX 77032

www.globaloring.com

PART
NUMBER

FRS2329A

Fabric Reinforced Oil Seal - Nitrile 90 Style A
Ref: JM Clipper 19339 H1L5

Information in this drawing is provided for reference only