

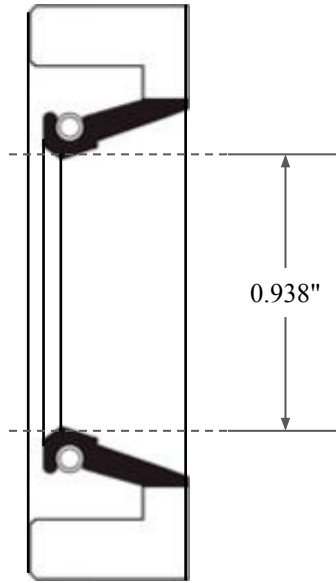

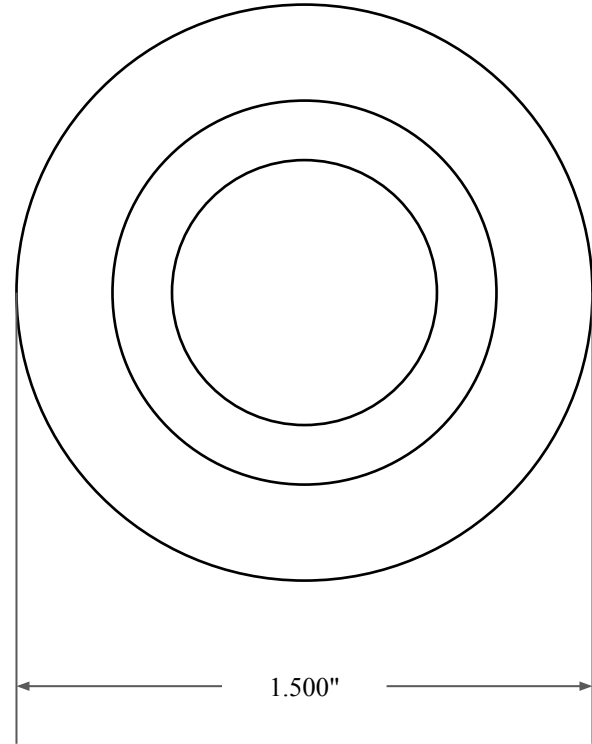

0.375"



0.938"



1.500"

 GLOBAL O-RING and SEAL ALL-AROUND BETTER	PART NUMBER FRS2471AV90
14450 John F. Kennedy Blvd. Houston, TX 77032	Fabric Reinforced Oil Seal - Viton 90 Style A Ref: JM Clipper 10229 HSL16
Information in this drawing is provided for reference only	