

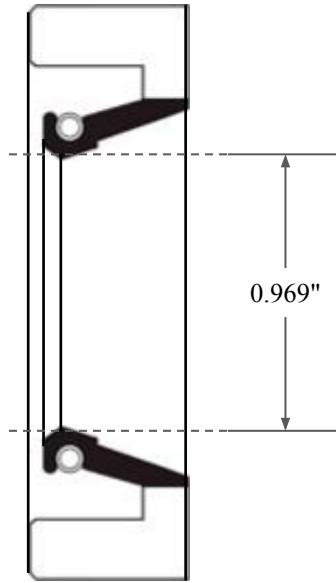

0.313"

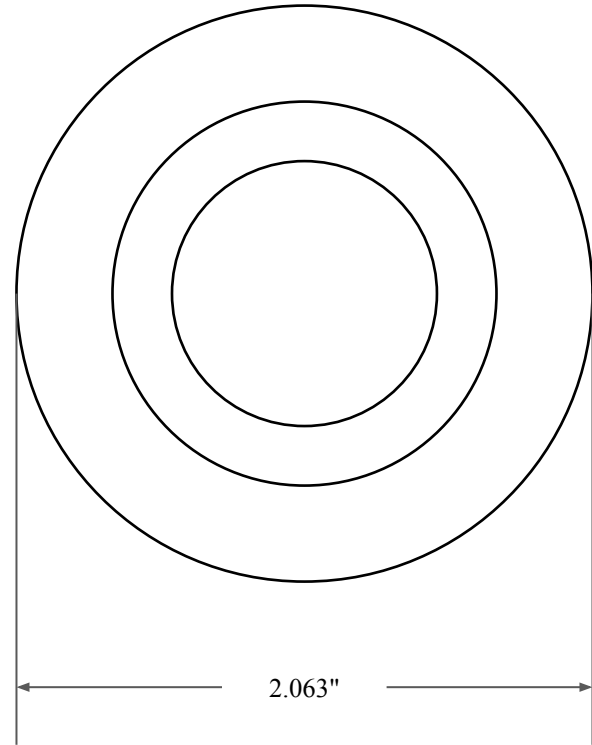

0.969"



2.063"



14450 John F. Kennedy Blvd.  
Houston, TX 77032

[www.globaloring.com](http://www.globaloring.com)

PART  
NUMBER

**FRS2629A**

Fabric Reinforced Oil Seal - Nitrile 90 Style A  
Ref: JM Clipper 11893 H1L5

Information in this drawing is provided for reference only