

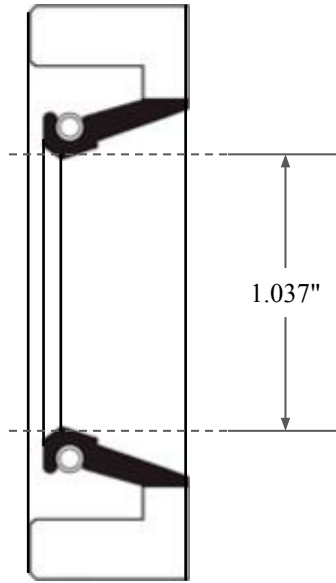

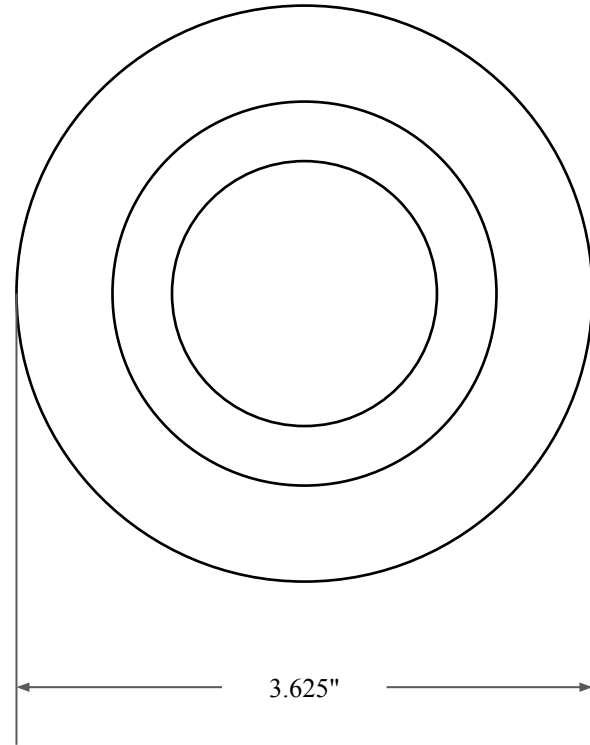

0.500"



1.037"



3.625"

 GLOBAL O-RING and SEAL ALL-AROUND BETTER	PART NUMBER FRS3065A
14450 John F. Kennedy Blvd. Houston, TX 77032	Fabric Reinforced Oil Seal - Nitrile 90 Style A Ref: JM Clipper 19013 H1L5
Information in this drawing is provided for reference only	