

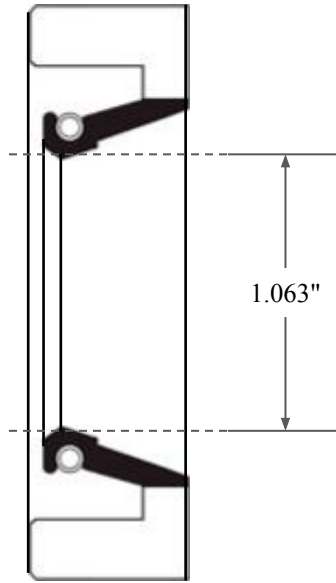

0.500"

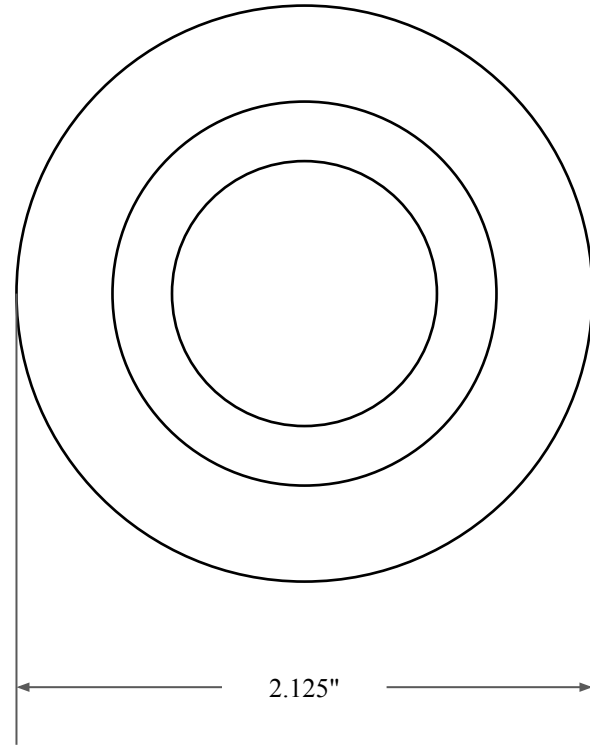

1.063"



2.125"



GLOBAL O-RING
and SEAL
ALL-AROUND BETTER

14450 John F. Kennedy Blvd.
Houston, TX 77032

www.globaloring.com

PART
NUMBER

FRS3205A

Fabric Reinforced Oil Seal - Nitrile 90 Style A
Ref: JM Clipper 10433 H1L5

Information in this drawing is provided for reference only