

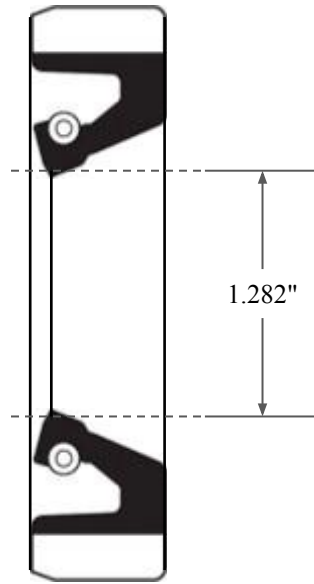

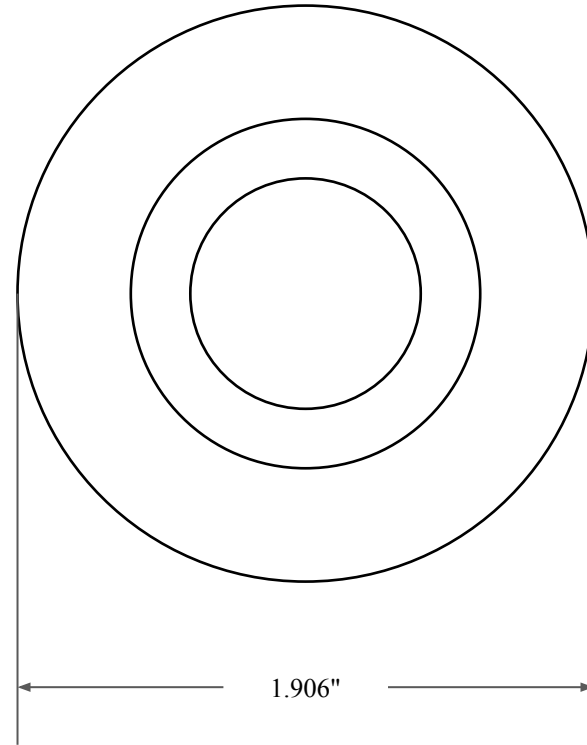

0.313"



1.282"



1.906"

 GLOBAL O-RING and SEAL ALL-AROUND BETTER	PART NUMBER FRS4301B
14450 John F. Kennedy Blvd. Houston, TX 77032	Fabric Reinforced Oil Seal - Nitrile 90 Style B Ref: JM Clipper 0128 9827
Information in this drawing is provided for reference only	