

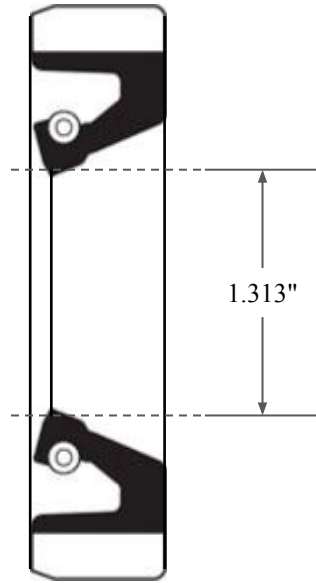

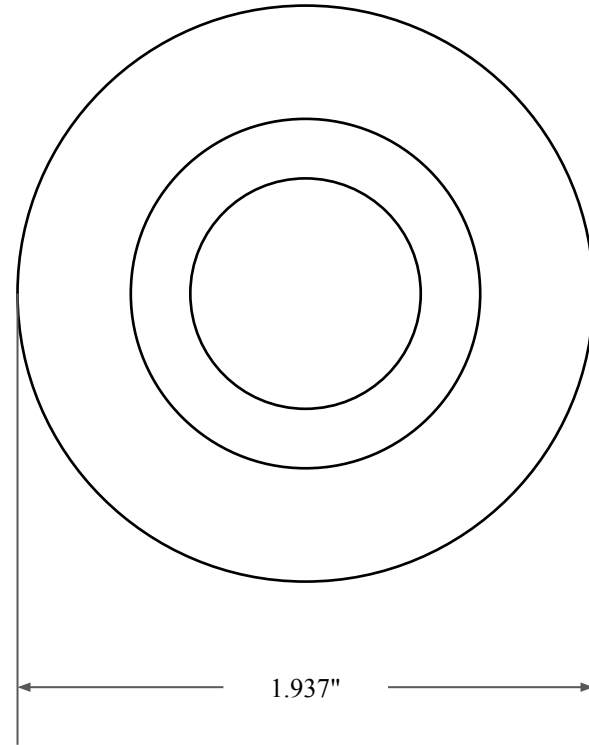

0.313"



1.313"



1.937"

 GLOBAL O-RING and SEAL ALL-AROUND BETTER	PART NUMBER FRS4424B
14450 John F. Kennedy Blvd. Houston, TX 77032	Fabric Reinforced Oil Seal - Nitrile 90 Style B Ref: JM Clipper 0131 4450
Information in this drawing is provided for reference only	