

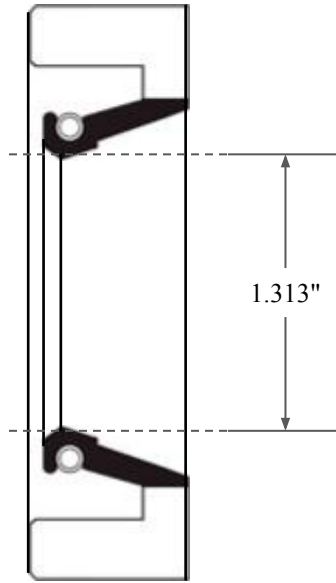

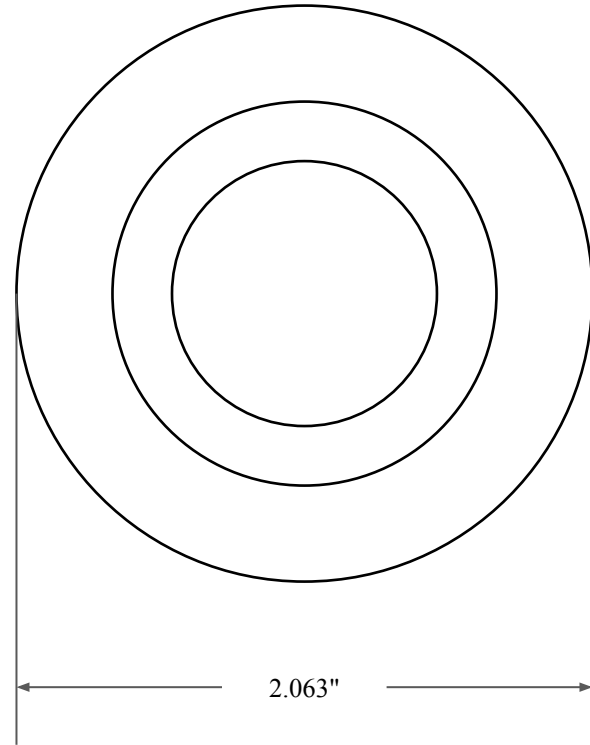

0.375"



1.313"



2.063"

 GLOBAL O-RING and SEAL ALL-AROUND BETTER	PART NUMBER FRS4435AV90
14450 John F. Kennedy Blvd. Houston, TX 77032	Fabric Reinforced Oil Seal - Viton 90 Style A Ref: JM Clipper 14341 HSL16
Information in this drawing is provided for reference only	