

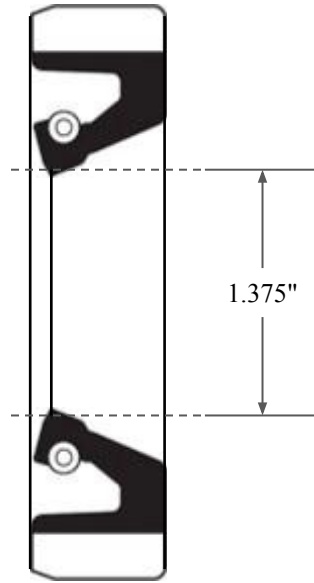

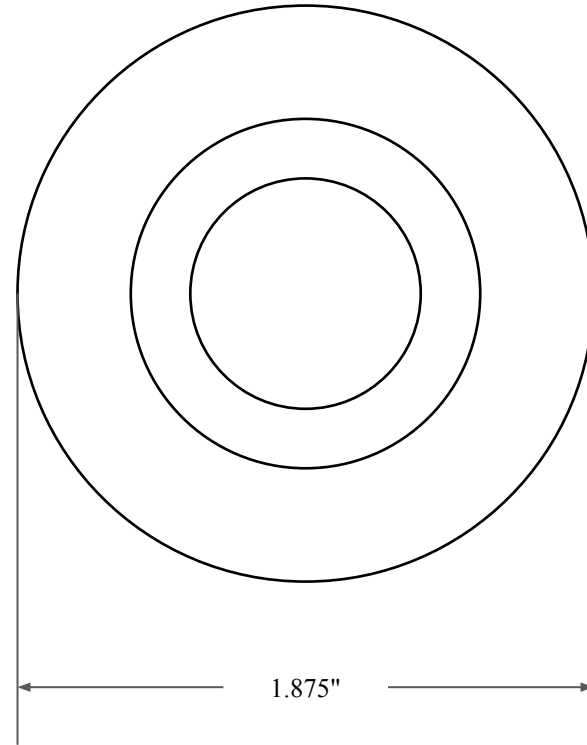

0.313"



1.375"



1.875"

 GLOBAL O-RING and SEAL ALL-AROUND BETTER	PART NUMBER FRS4619B
14450 John F. Kennedy Blvd. Houston, TX 77032	Fabric Reinforced Oil Seal - Nitrile 90 Style B Ref: JM Clipper 0137 5866
Information in this drawing is provided for reference only	