

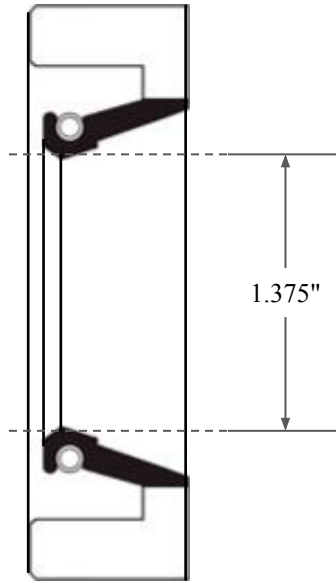

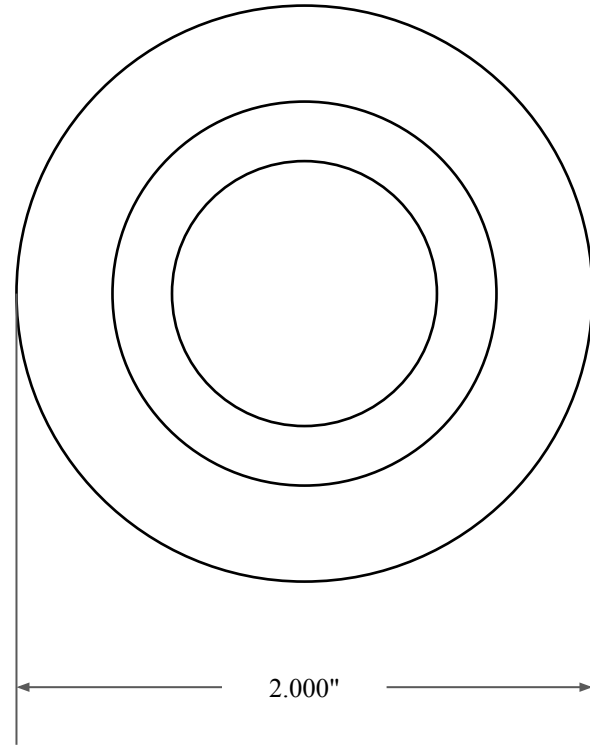

0.313"



1.375"



2.000"

 <p><b>GLOBAL O-RING</b> and SEAL ALL-AROUND BETTER</p>	PART NUMBER <b>FRS4636ANT</b>
14450 John F. Kennedy Blvd. Houston, TX 77032	Fabric Reinforced Oil Seal - Nitrile/PTFE 75 Style A Ref: JM Clipper 10485 HIL5 PTFE
Information in this drawing is provided for reference only	