

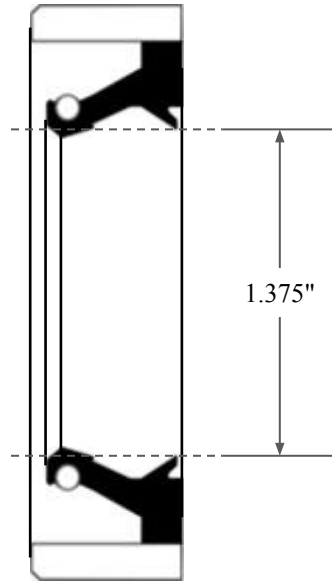

0.438"

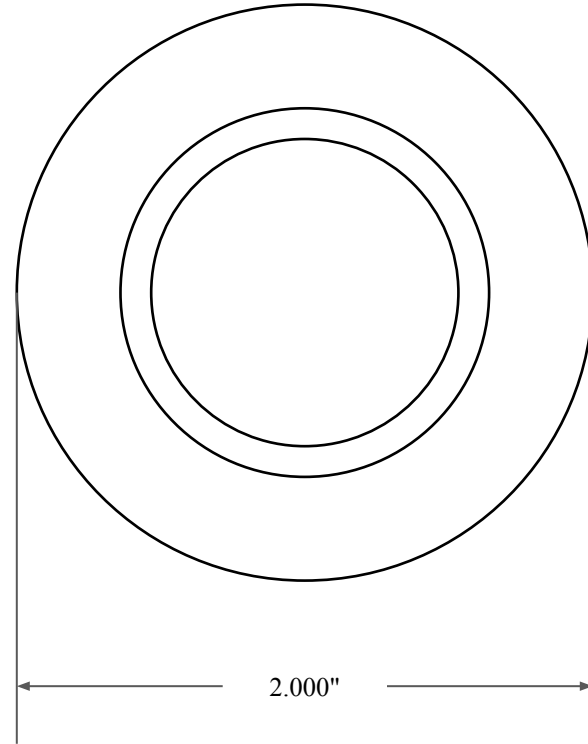

1.375"



2.000"

 GLOBAL O-RING and SEAL ALL-AROUND BETTER	PART NUMBER FRS4641CV90
14450 John F. Kennedy Blvd. Houston, TX 77032	Fabric Reinforced Oil Seal - Viton 90 Style C Ref: JM Clipper 17692 HSL16
Information in this drawing is provided for reference only	