

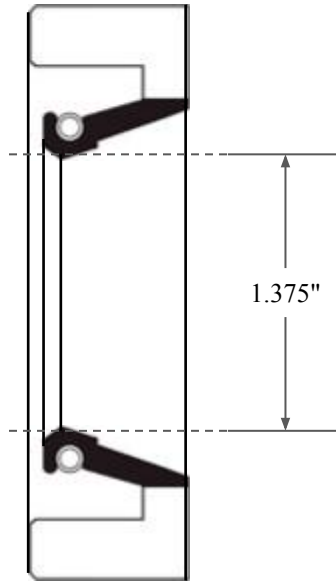

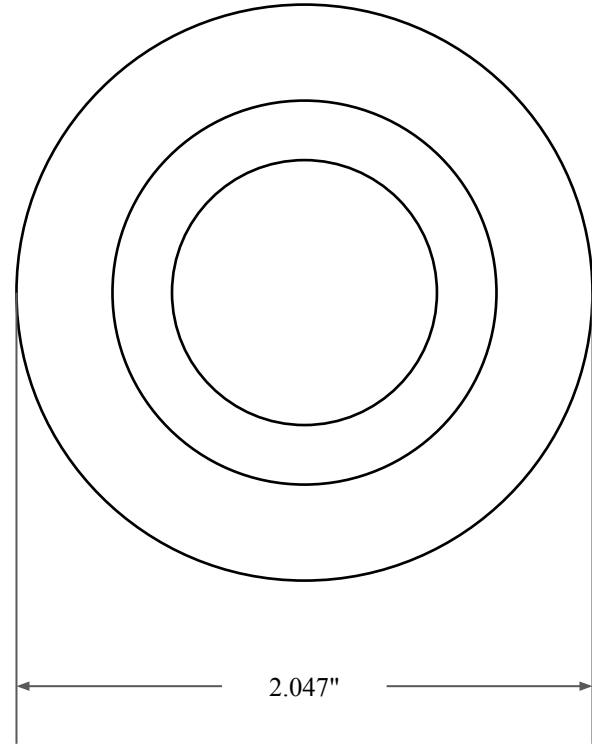

0.438"



1.375"



2.047"

 <p><b>GLOBAL O-RING</b> and SEAL ALL-AROUND BETTER</p>	PART NUMBER <b>FRS4645AV90</b>
14450 John F. Kennedy Blvd. Houston, TX 77032	Fabric Reinforced Oil Seal - Viton 90 Style A Ref: JM Clipper 9755 H5L16
Information in this drawing is provided for reference only	