

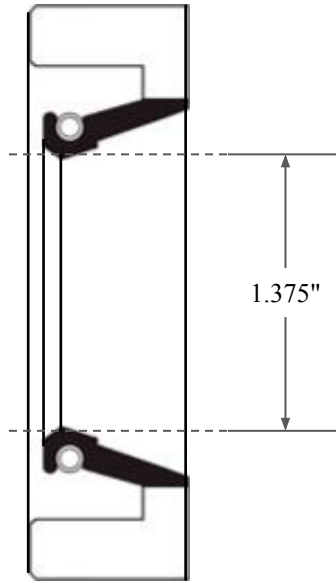

0.375"

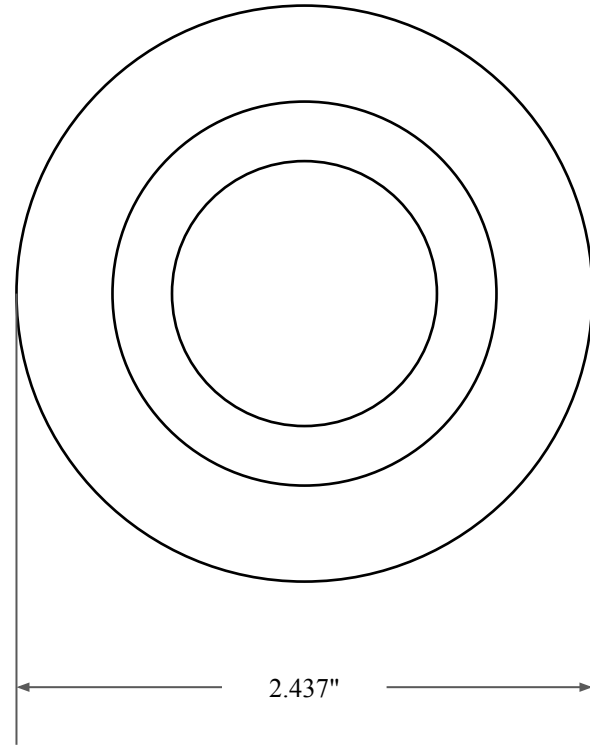

1.375"



2.437"



14450 John F. Kennedy Blvd.
Houston, TX 77032

www.globaloring.com

PART
NUMBER

FRS4697AV90

Fabric Reinforced Oil Seal - Viton 90 Style A
Ref: JM Clipper 5731 H5L16

Information in this drawing is provided for reference only