

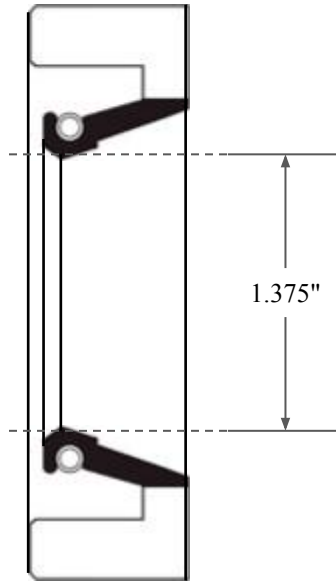

0.375"

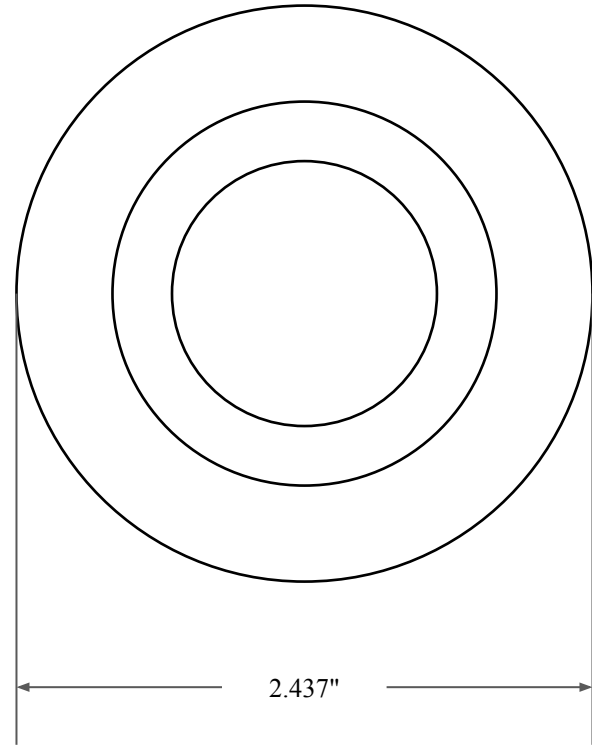

1.375"



2.437"



14450 John F. Kennedy Blvd.  
Houston, TX 77032

[www.globaloring.com](http://www.globaloring.com)

PART  
NUMBER

**FRS4697A**

Fabric Reinforced Oil Seal - Nitrile 90 Style A  
Ref: JM Clipper 5731 HIL5

Information in this drawing is provided for reference only