

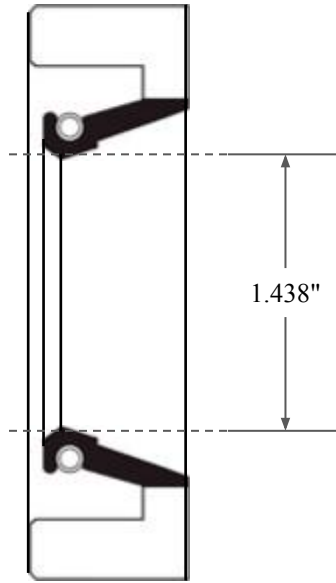

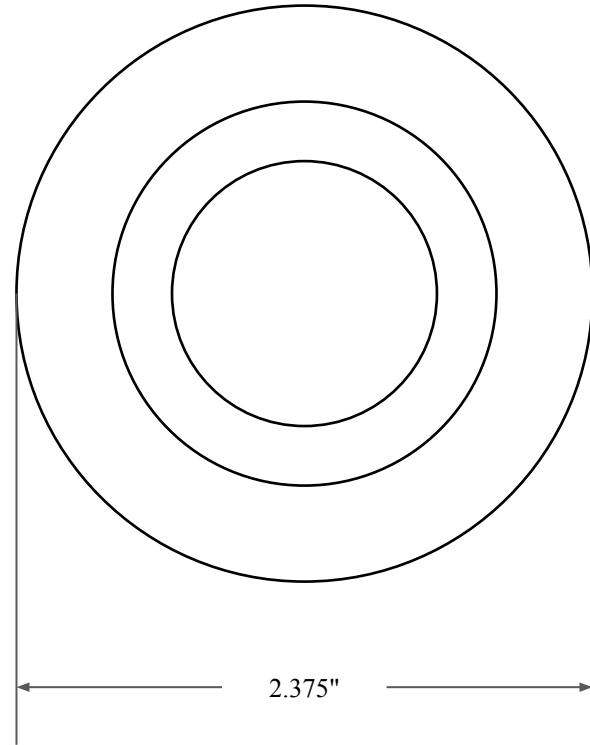

0.500"



1.438"



2.375"

 <p>GLOBAL O-RING and SEAL ALL-AROUND BETTER</p>	PART NUMBER FRS5108AV90
14450 John F. Kennedy Blvd. Houston, TX 77032	Fabric Reinforced Oil Seal - Viton 90 Style A Ref: JM Clipper 9454 H5L16
Information in this drawing is provided for reference only	