

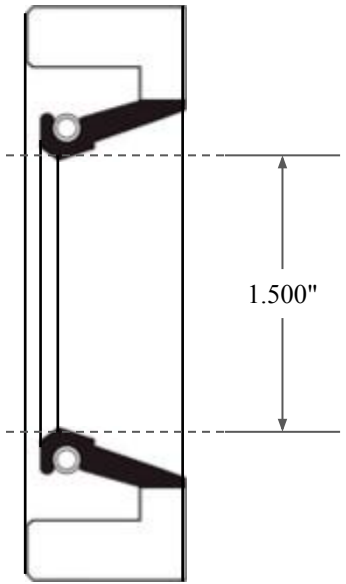

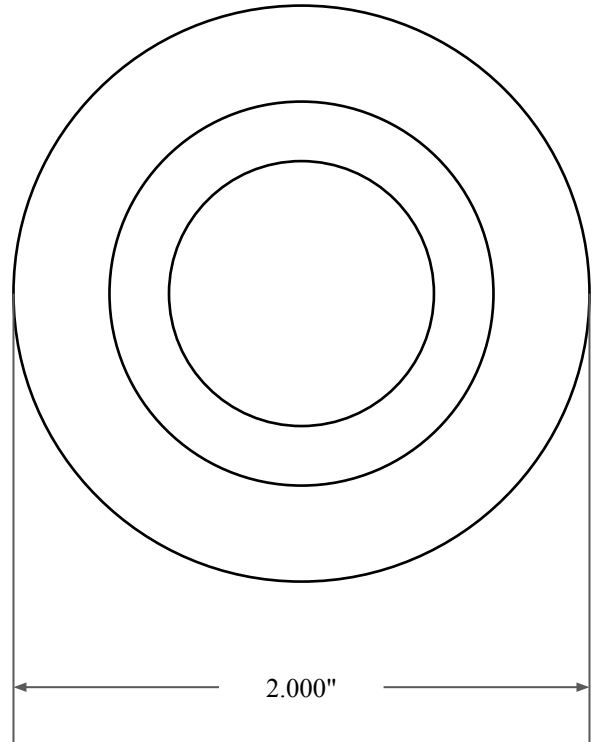

0.250"



1.500"



2.000"

 <p>GLOBAL O-RING and SEAL ALL-AROUND BETTER</p>	PART NUMBER FRS5346AVT90
14450 John F. Kennedy Blvd. Houston, TX 77032	Fabric Reinforced Oil Seal - Viton/PTFE 90 Style A Ref: JM Clipper 9831 H5L16 PTFE
Information in this drawing is provided for reference only	