

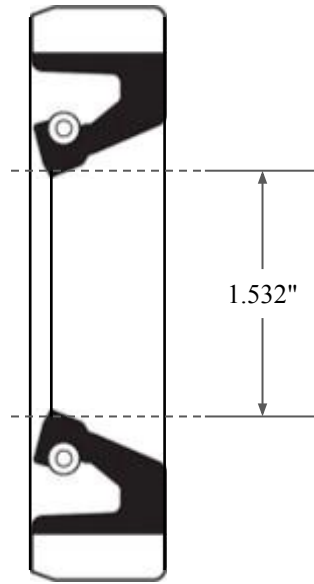

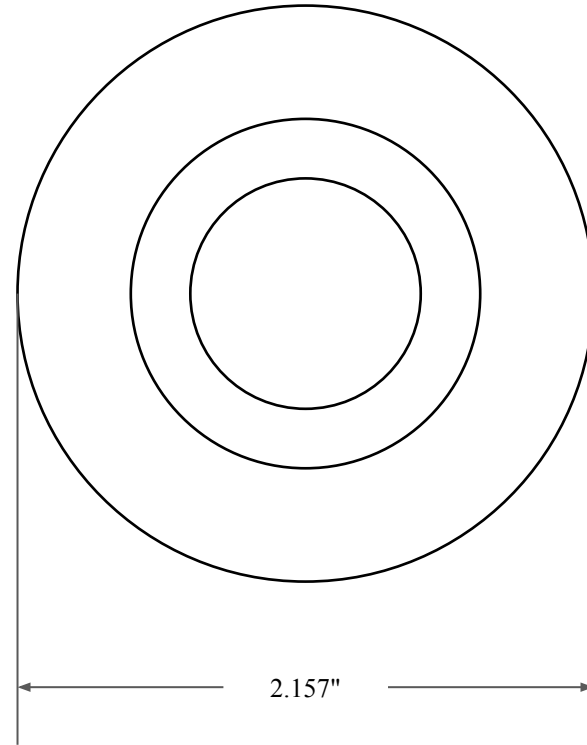

0.313"



1.532"



2.157"

 GLOBAL O-RING and SEAL ALL-AROUND BETTER	PART NUMBER FRS5519B
14450 John F. Kennedy Blvd. Houston, TX 77032	Fabric Reinforced Oil Seal - Nitrile 90 Style B Ref: JM Clipper 0153 9628
Information in this drawing is provided for reference only	