

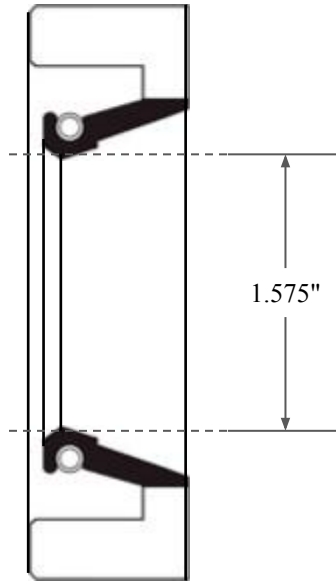

0.375"

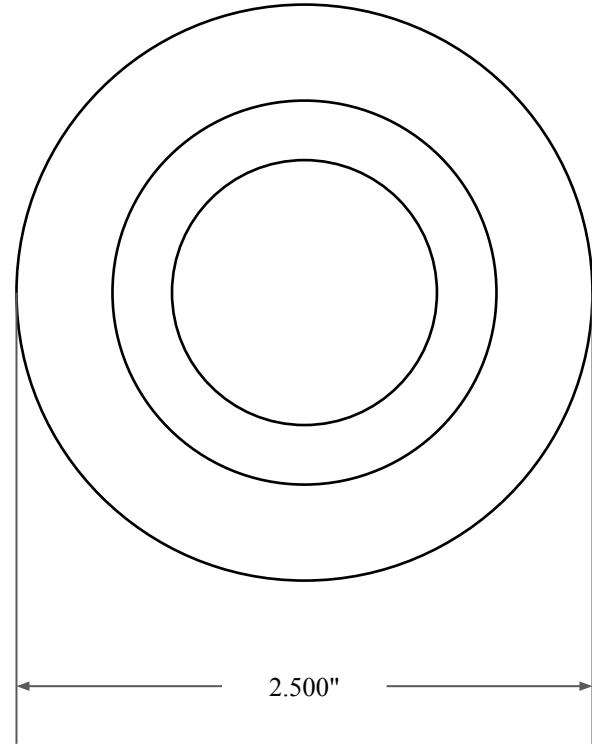

1.575"



2.500"



14450 John F. Kennedy Blvd.
Houston, TX 77032

www.globaloring.com

PART
NUMBER

FRS5790A

Fabric Reinforced Oil Seal - Nitrile 90 Style A
Ref: JM Clipper 11302 H1L5

Information in this drawing is provided for reference only