

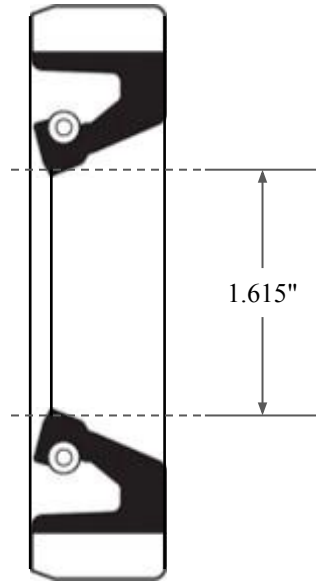

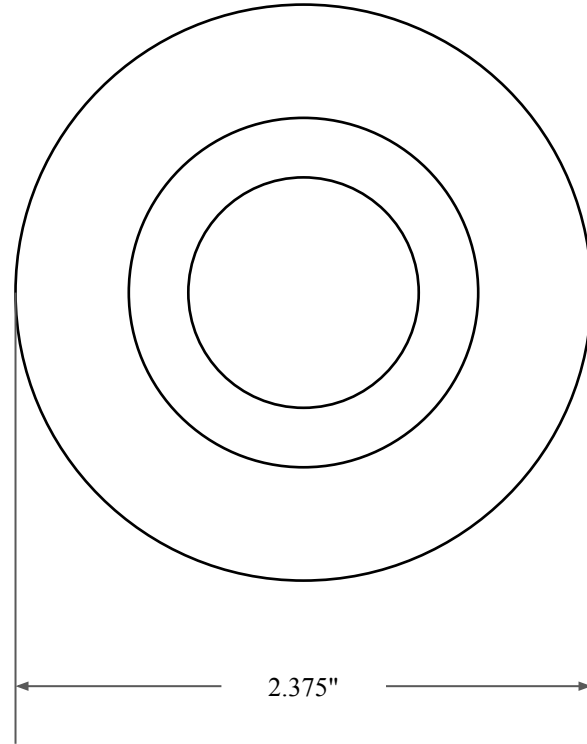

0.375"



1.615"



2.375"

 GLOBAL O-RING and SEAL ALL-AROUND BETTER	PART NUMBER FRS5924B
14450 John F. Kennedy Blvd. Houston, TX 77032	Fabric Reinforced Oil Seal - Nitrile 90 Style B Ref: JM Clipper 4459 H1L5
Information in this drawing is provided for reference only	