

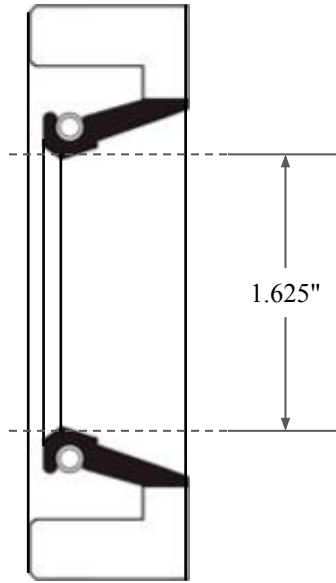

0.250"

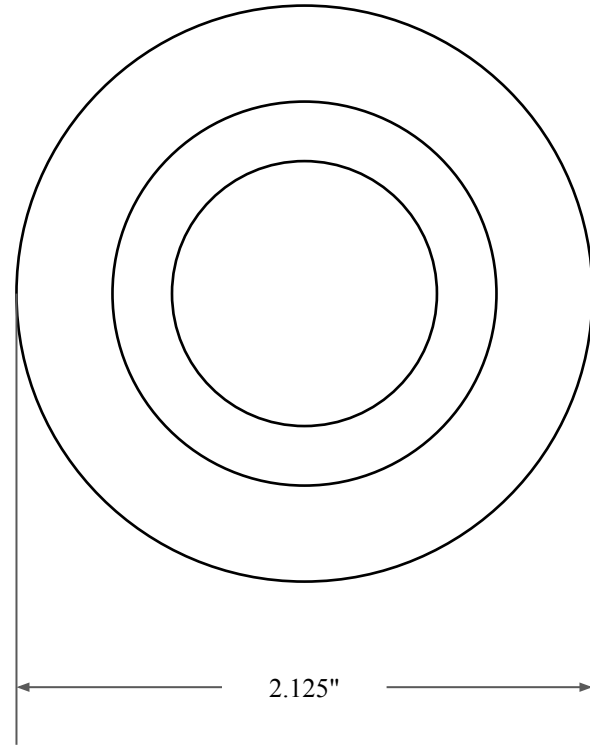

1.625"



2.125"



14450 John F. Kennedy Blvd.
Houston, TX 77032

www.globaloring.com

PART
NUMBER

FRS5954A

Fabric Reinforced Oil Seal - Nitrile 90 Style A
Ref: JM Clipper 19248 H1L5

Information in this drawing is provided for reference only