

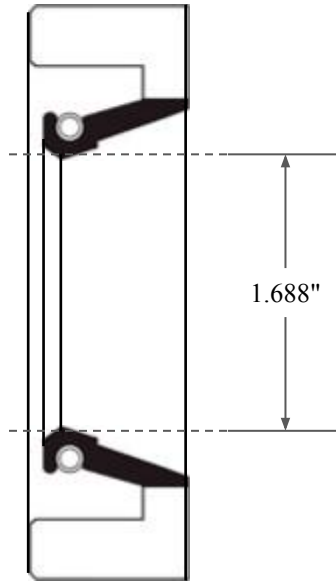

0.375"

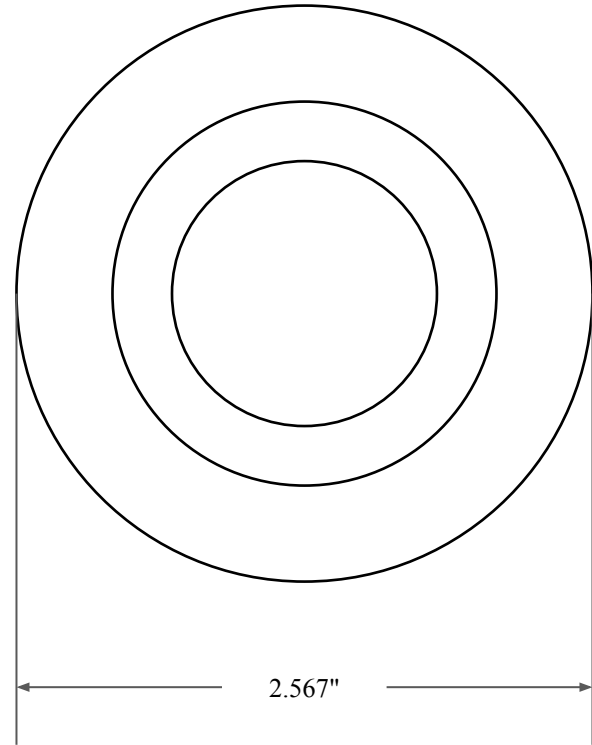

1.688"



2.567"



14450 John F. Kennedy Blvd.
Houston, TX 77032

www.globaloring.com

PART
NUMBER

FRS6257A

Fabric Reinforced Oil Seal - Nitrile 90 Style A
Ref: JM Clipper 7182 H1L5

Information in this drawing is provided for reference only