

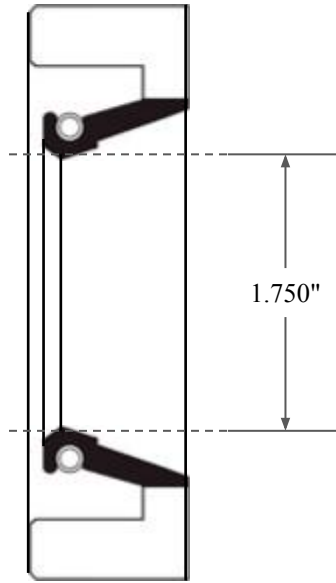

0.375"

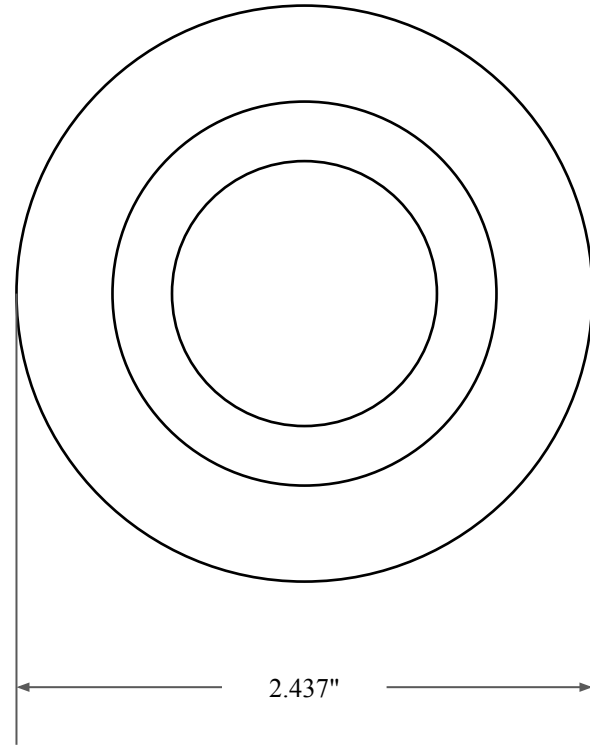

1.750"



2.437"



14450 John F. Kennedy Blvd.  
Houston, TX 77032

[www.globaloring.com](http://www.globaloring.com)

PART  
NUMBER

**FRS6477AV90**

Fabric Reinforced Oil Seal - Viton 90 Style A  
Ref: JM Clipper 9799 H5L16

Information in this drawing is provided for reference only