

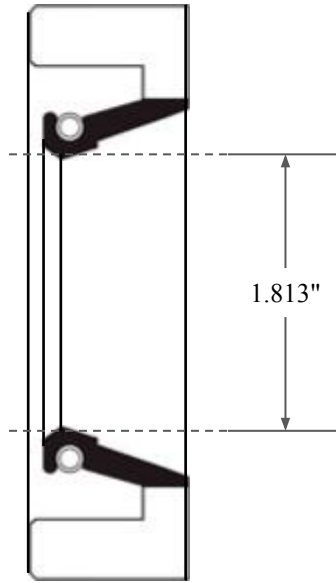

0.500"

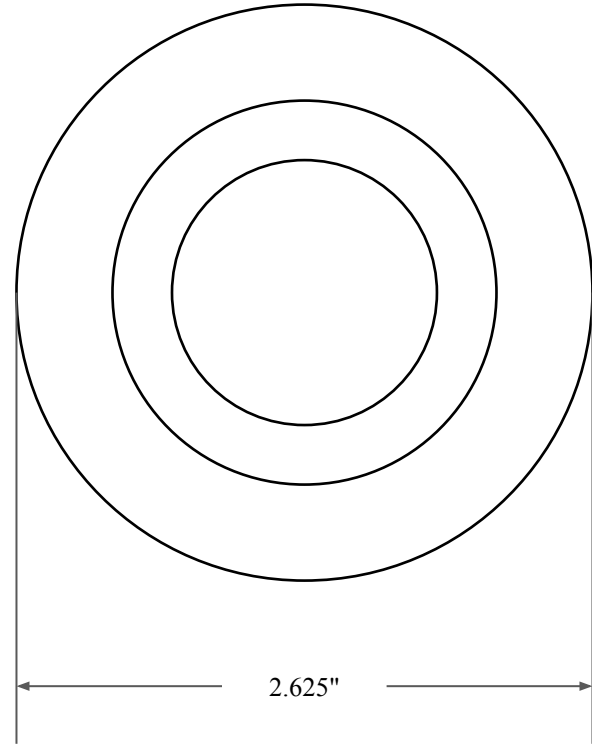

1.813"



2.625"



14450 John F. Kennedy Blvd.
Houston, TX 77032

www.globaloring.com

PART
NUMBER

FRS6877A

Fabric Reinforced Oil Seal - Nitrile 90 Style A
Ref: JM Clipper 15020 H1L5

Information in this drawing is provided for reference only