

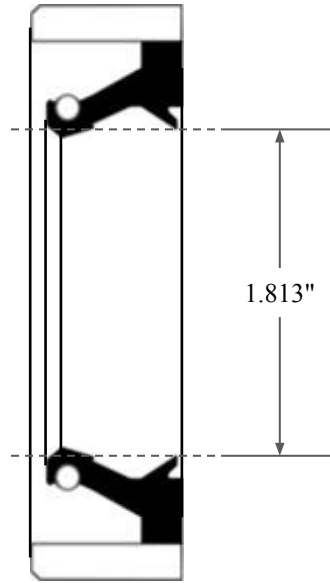

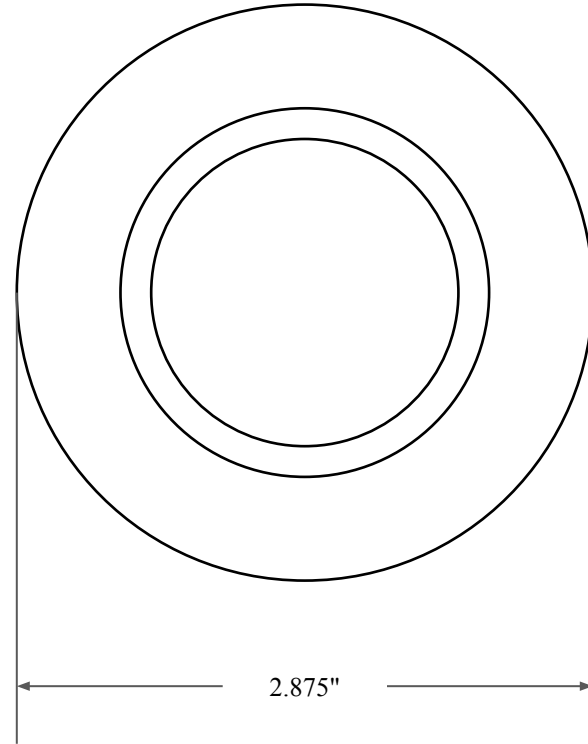

0.500"



1.813"



2.875"

 GLOBAL O-RING and SEAL ALL-AROUND BETTER	PART NUMBER FRS6886C
14450 John F. Kennedy Blvd. Houston, TX 77032 www.globaloring.com	Fabric Reinforced Oil Seal - Nitrile 90 Style C Ref: JM Clipper 13922 H1L5
Information in this drawing is provided for reference only	