

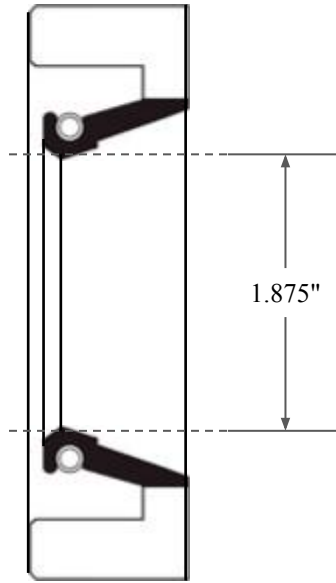

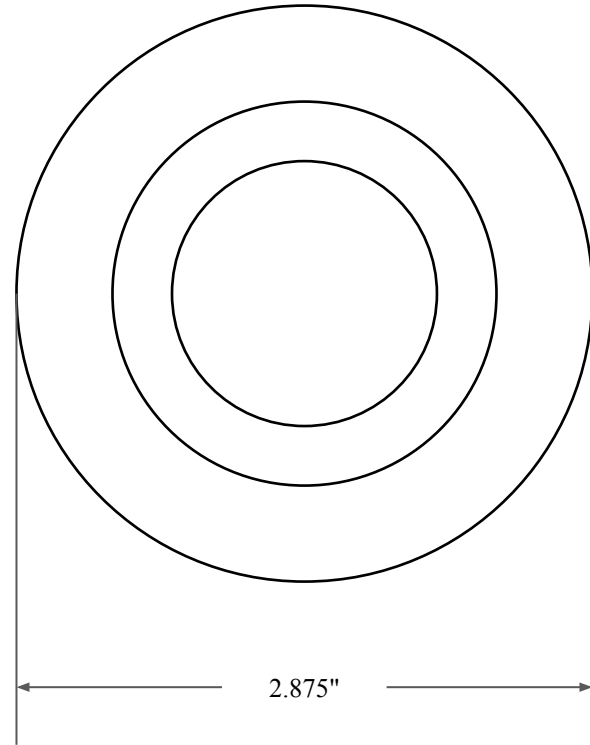

0.500"



1.875"



2.875"

 GLOBAL O-RING and SEAL ALL-AROUND BETTER	PART NUMBER FRS7052AV90
14450 John F. Kennedy Blvd. Houston, TX 77032	Fabric Reinforced Oil Seal - Viton 90 Style A Ref: JM Clipper 6936 H5L16
Information in this drawing is provided for reference only	