

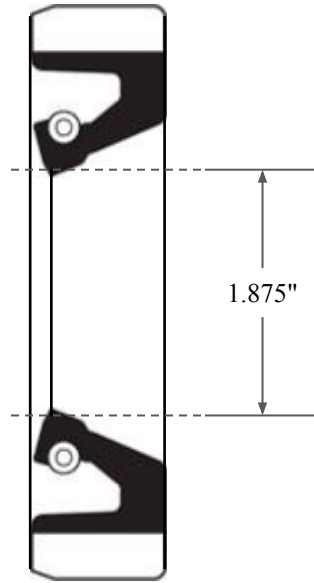

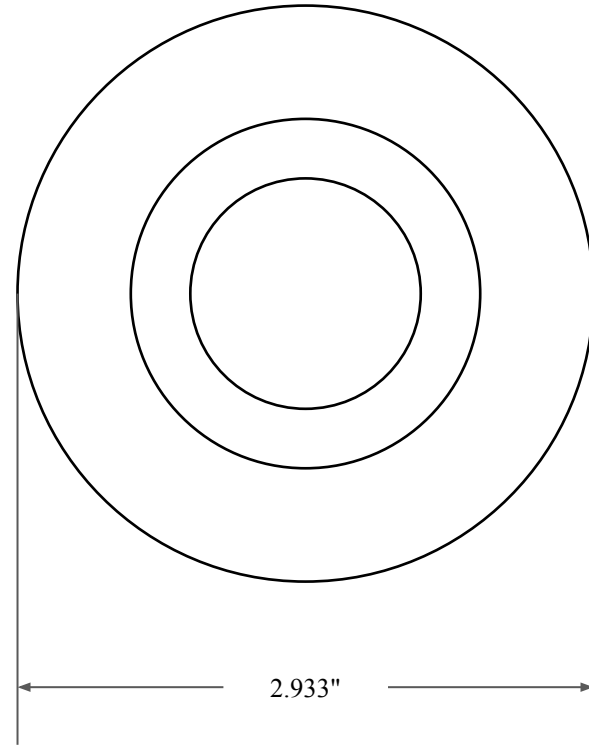

0.438"



1.875"



2.933"

 GLOBAL O-RING and SEAL ALL-AROUND BETTER	PART NUMBER FRS7057B
14450 John F. Kennedy Blvd. Houston, TX 77032	Fabric Reinforced Oil Seal - Nitrile 90 Style B Ref: JM Clipper 0187 13328
Information in this drawing is provided for reference only	