

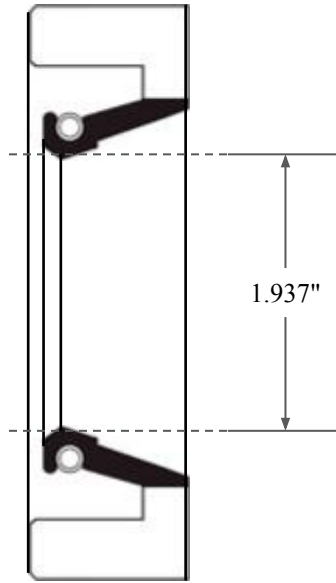

0.375"

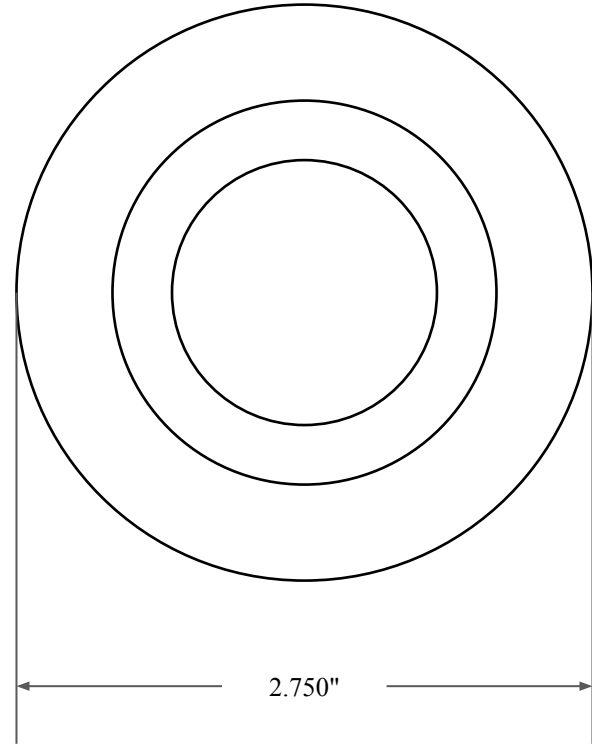

1.937"



2.750"



14450 John F. Kennedy Blvd.
Houston, TX 77032

www.globaloring.com

PART
NUMBER

FRS7272AV90

Fabric Reinforced Oil Seal - Viton 90 Style A
Ref: JM Clipper 9596 H5L16

Information in this drawing is provided for reference only