

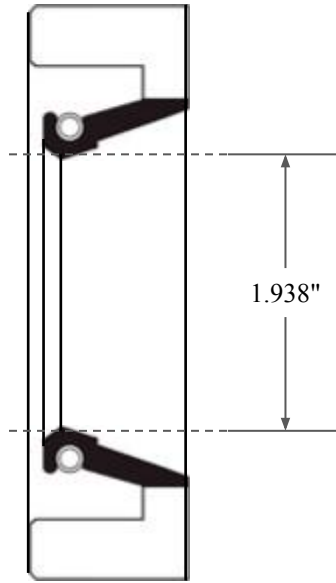

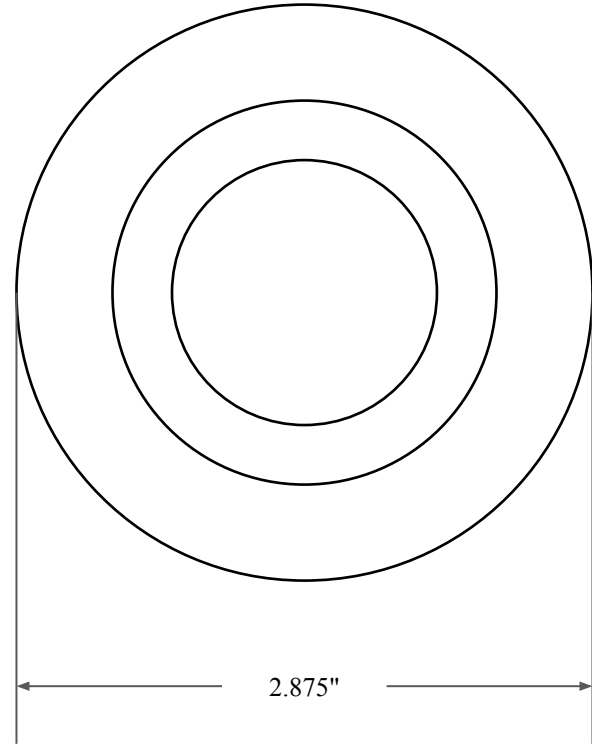

0.438"



1.938"



2.875"

 GLOBAL O-RING and SEAL ALL-AROUND BETTER	PART NUMBER FRS7325AVT90
14450 John F. Kennedy Blvd. Houston, TX 77032 www.globaloring.com	Fabric Reinforced Oil Seal - Viton/PTFE 90 Style A Ref: JM Clipper 8874 H5L16 PTFE
Information in this drawing is provided for reference only	