

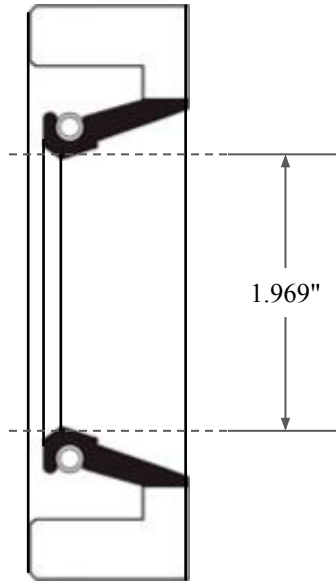

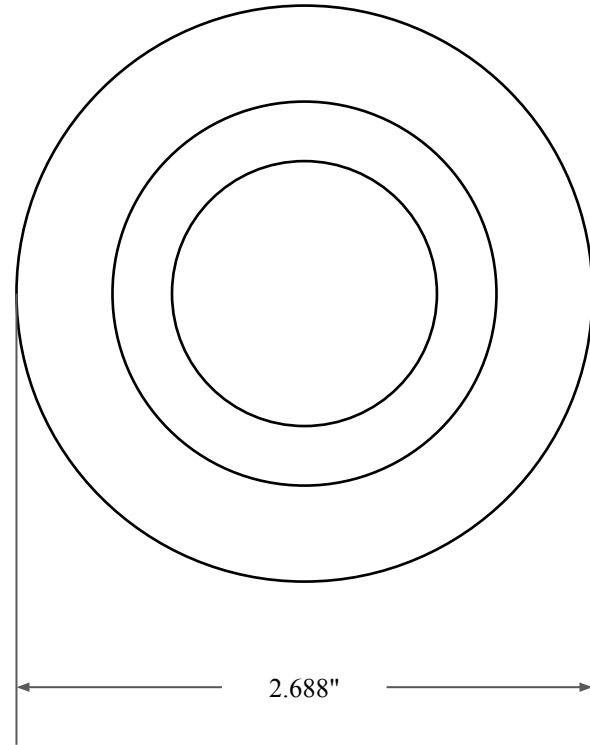

0.375"



1.969"



2.688"

 GLOBAL O-RING and SEAL ALL-AROUND BETTER	PART NUMBER FRS7438AV90
14450 John F. Kennedy Blvd. Houston, TX 77032	Fabric Reinforced Oil Seal - Viton 90 Style A Ref: JM Clipper 9397 H5L16
Information in this drawing is provided for reference only	