

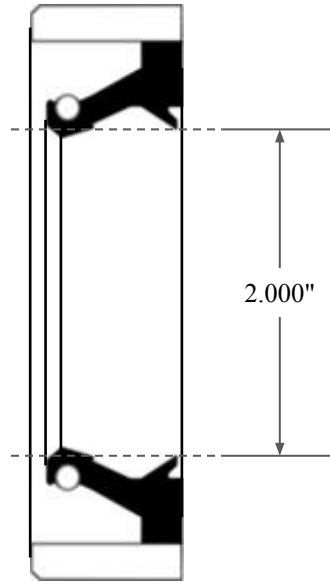

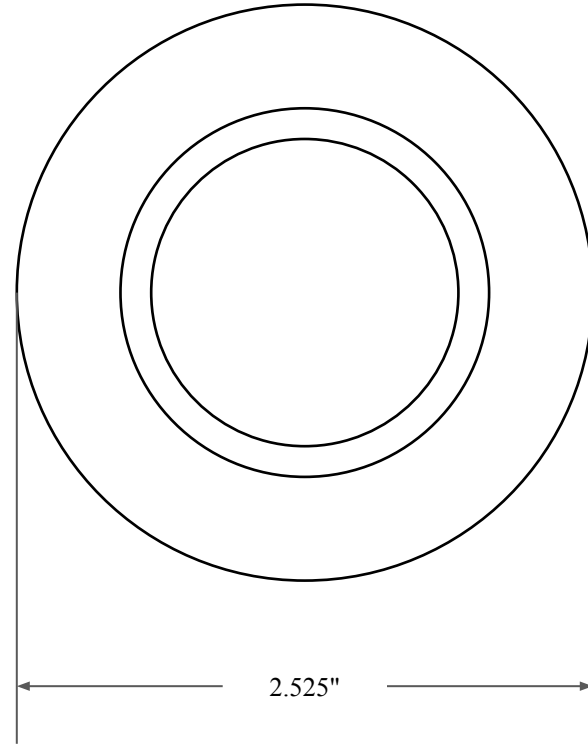

0.281"



2.000"



2.525"

 <b>GLOBAL O-RING</b> and SEAL ALL-AROUND BETTER	PART NUMBER <b>FRS7554C</b>
14450 John F. Kennedy Blvd. Houston, TX 77032	Fabric Reinforced Oil Seal - Nitrile 90 Style C Ref: JM Clipper 19224 H1L5
Information in this drawing is provided for reference only	