

0.250"

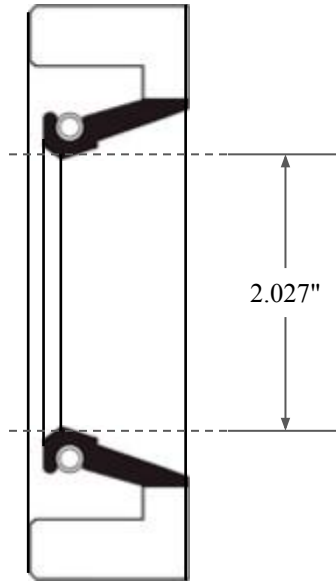

2.027"

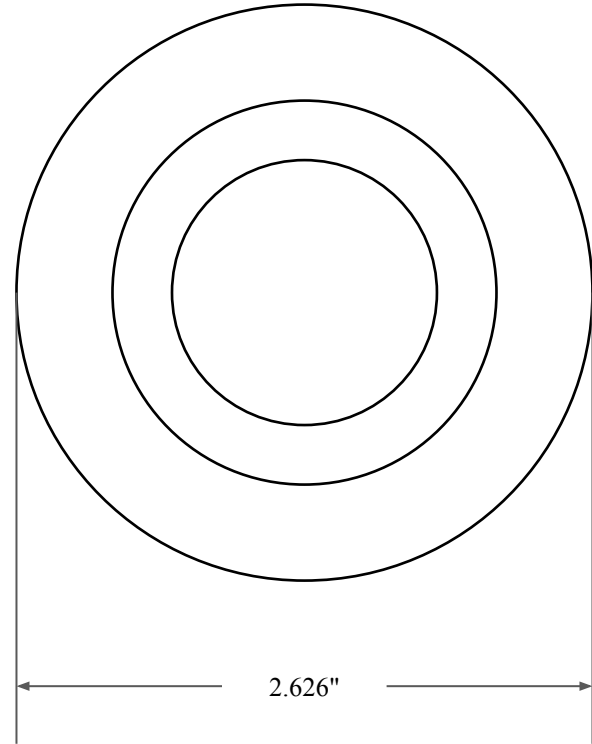

2.626"



14450 John F. Kennedy Blvd. www.globaloring.com
Houston, TX 77032

Information in this drawing is provided for reference only

PART
NUMBER

FRS7720A

Fabric Reinforced Oil Seal - Nitrile 90 Style A
Ref: JM Clipper 15882 H1L5