

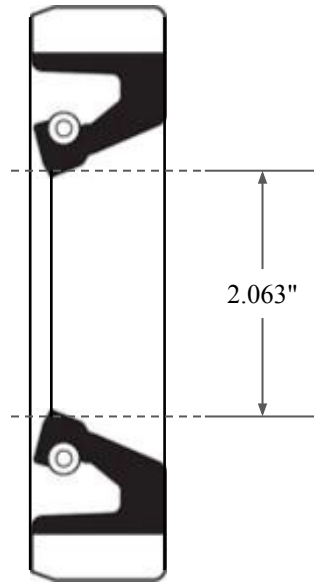

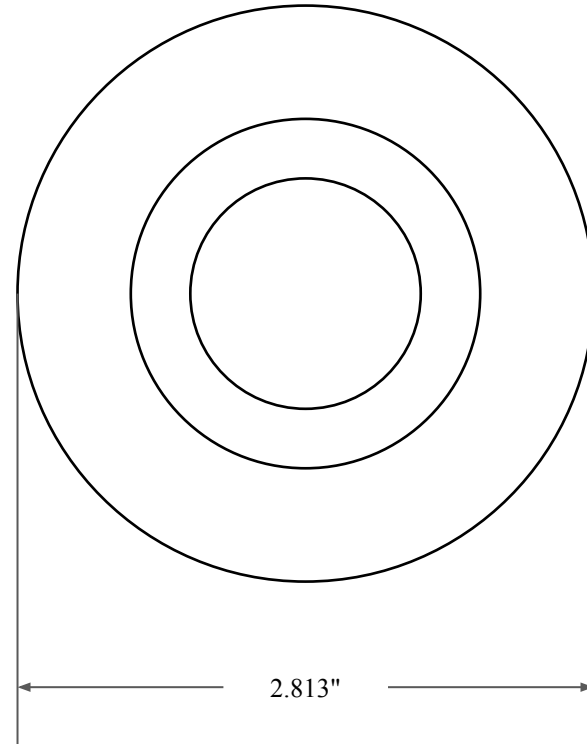

0.438"



2.063"



2.813"

 GLOBAL O-RING and SEAL ALL-AROUND BETTER	PART NUMBER FRS7840B
14450 John F. Kennedy Blvd. Houston, TX 77032 www.globaloring.com	Fabric Reinforced Oil Seal - Nitrile 90 Style B Ref: JM Clipper 0206 14922
Information in this drawing is provided for reference only	