

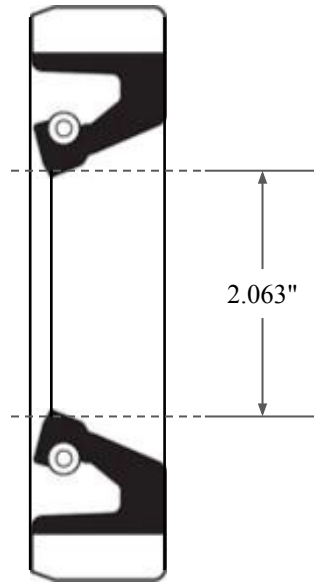

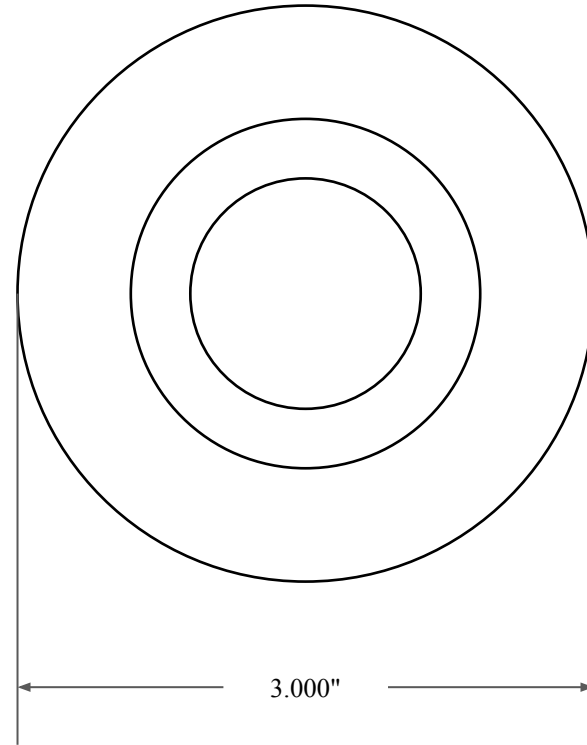

0.438"



2.063"



3.000"

 GLOBAL O-RING and SEAL ALL-AROUND BETTER	PART NUMBER FRS7849B
14450 John F. Kennedy Blvd. Houston, TX 77032	Fabric Reinforced Oil Seal - Nitrile 90 Style B Ref: JM Clipper 0206 3838
Information in this drawing is provided for reference only	