

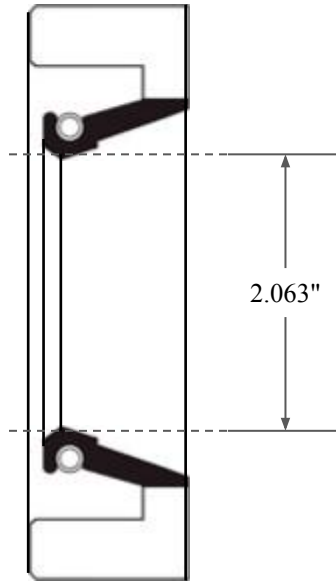

0.438"

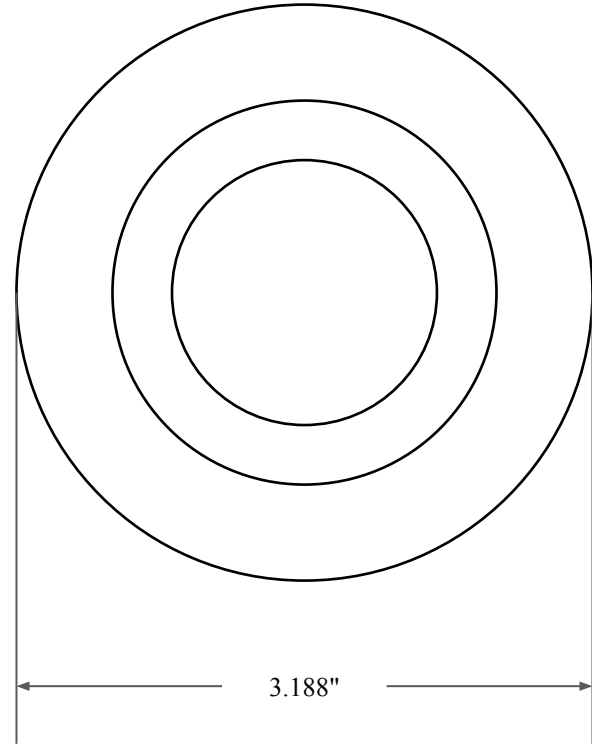

2.063"



3.188"



14450 John F. Kennedy Blvd.
Houston, TX 77032

www.globaloring.com

PART
NUMBER

FRS7859A

Fabric Reinforced Oil Seal - Nitrile 90 Style A
Ref: JM Clipper 10701 H1L5

Information in this drawing is provided for reference only